

iNFCONE
GROUPE
VOYONS PLUS GRAND

DISPLAYS
01

Valorisez Votre Identité Visuelle

Depuis 2006, INFO-ONE Groupe développe votre identité visuelle au niveau national et international en vous accompagnant de la création à la fabrication jusqu'à la pose du support.

VOYONS PLUS **GRAND**

SIGNALÉTIQUE | IMPRIMERIE | ENSEIGNE

ACCOMPAGNEMENT

La solution à votre besoin

Vous avez un besoin, nous savons y répondre. Notre expertise nous permet de vous proposer des solutions sur mesures et de vous guider dans le choix des matériaux et des supports tout en respectant vos contraintes techniques et budgétaires.

CONCEPTION

Notre maîtrise graphique à votre image

Agence de production spécialisée en marquage publicitaire et communication imprimée, notre bureau d'étude et de design et nos techniciens mettent tout en œuvre pour sublimer votre image et vos messages.

INFO-ONE groupe est le partenaire idéal pour votre communication de marque, la mise en place d'une stratégie marketing, la création de visuel et développement de votre image au sein de votre entreprise et bien plus.

PRODUCTION

Nos ateliers à votre service

En privilégiant des matériaux de qualité et des fournisseurs fiables, nous garantissons la tenue de nos produits.

Partenaire Hexis, leader du marché des adhésifs en Europe et référence du secteur en terme de qualité et test de ses produits, nous fabriquons l'ensemble des supports dans nos ateliers de production en région parisienne.

LOGISTIQUE & POSE

La précision et la maîtrise des chantiers de A à Z

Nos commerciaux suivent chaque dossiers et vous accompagnent dans toutes vos démarches en alliant la productivité à vos impératifs de temps.

Comme efficacité rime avec dossiers bien préparés, nos techniciens expérimentés et poseurs certifiés maîtrisent et finalisent les chantiers suivant le cahier des charges.

*Reconnu dans le secteur, INFO-ONE groupe est votre partenaire idéal.
Alors ensemble, **Voyons plus grand !***

DISPLAYS 01

Complete range of portable displays which provide an integral solution for the exhibition at promotional events, stores or business presentations.

- 4** X-BANNER
- 8** L-BANNER
- 10** ROLL UP | ECONOMIC
- 14** ROLL UP | STANDARD
- 18** ROLL UP | STYLISH
- 23** ROLL UP | DELUXE
- 29** ROLL UP | LARGE
- 33** ROLL UP ACCESSORIES
- 36** DESKTOP DISPLAYS
- 38** STAND DISPLAYS
- 47** REFILLABLE BASES
- 50** DISPLAY BASES
- 56** SIDEWALK BOARDS



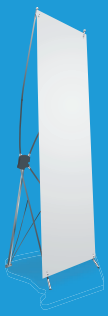

X-BANNER Display



DISPLAY DETAILS

GRAPHIC BY EYELETS



DIMENSIONS

*mm

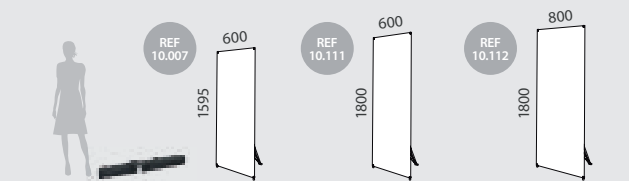

INFORMATION

Tudela X-Banner is a portable, detachable and lightweight display for interchangeable graphics. Its X-shaped structure is made of fiberglass and plastic. The exhibitors can quickly assemble it in a few seconds (no tools required). Tudela features 3 sizes available and it includes a nylon carry bag.

600x1595	QTY	N.W	G.W	C.B.M	SIZE
Packing	10	9kg	10kg	0.0525	1010x200x260mm
Uni.	1	0.90kg	1kg	0.005	160x30x1080mm
10.007	Graphic Size: 600x1595mm				
600x1800	QTY	N.W	G.W	C.B.M	SIZE
Packing	10	9.5kg	10.5kg	0.0629	1210x200x260mm
Uni.	1	0.95kg	1.05kg	0.007	160x40x1210mm
10.111	Graphic Size: 600x1800mm				
800x1800	QTY	N.W	G.W	C.B.M	SIZE
Packing	10	10kg	11kg	0.0629	1210x200x260mm
Uni.	1	1kg	1.1kg	0.008	170x40x1210mm
10.112	Graphic Size: 800x1800mm				

TUDELA



DISPLAY DETAILS

GRAPHIC BY EYELETS

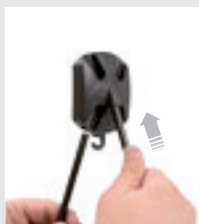

DIMENSIONS

*mm

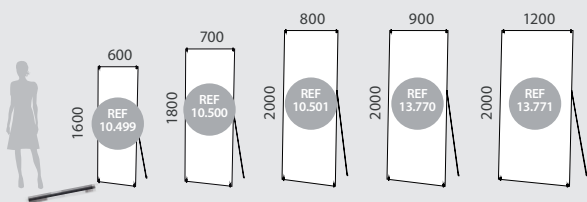

INFORMATION

The Lyon X-Banner is a portable, detachable and very lightweight display for interchangeable graphics. Its X-shaped structure is made of fiberglass and plastic. Quickly assembly in seconds (no tools required). It includes a nylon carry bag. Lyon features 5 sizes available.

600x1600	QTY	N.W	G.W	C.B.M	SIZE
Packing	50	16.5kg	17.5kg	0.1298	350x350x1060mm
Uni.	1	0.30kg	0.35kg	0.009	140x60x1060mm
10.499	Graphic Size: 600x1600mm				

700x1800	QTY	N.W	G.W	C.B.M	SIZE
Packing	50	20kg	22kg	0.1484	400x350x1060mm
Uni.	1	0.35kg	0.40kg	0.009	140x60x1060mm
10.500	Graphic Size: 700x1800mm				

800x2000	QTY	N.W	G.W	C.B.M	SIZE
Packing	50	22.5kg	23.5kg	0.192	400x400x1200mm
Uni.	1	0.40kg	0.45kg	0.01	140x60x1200mm
10.501	Graphic Size: 800x2000mm				

900x2000	QTY	N.W	G.W	C.B.M	SIZE
Packing	20	14.6kg	15.7kg	0.178	1210x410x360mm
Uni.	1	0.73kg	1kg	0.01	140x60x1200mm
13.770	Graphic Size: 900x2000mm				

1200x2000	QTY	N.W	G.W	C.B.M	SIZE
Packing	20	22kg	23.2kg	0.193	1260x510x300mm
Uni.	1	1.1kg	1.3kg	0.01	140x60x1200mm
13.771	Graphic Size: 1200x2000mm				

LYON



“ get extra tension using the hook with a counterweight ”

DISPLAY DETAILS



DISPLAY DETAILS

GRAPHIC ATTACHMENT BY EYELETS



DIMENSIONS

*mm

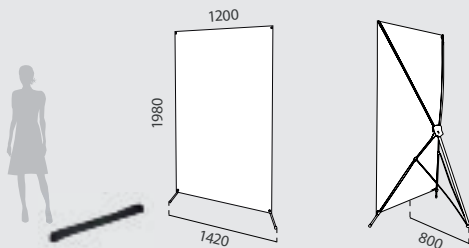

INFORMATION

Valoria X-Banner is a portable, detachable and lightweight display for interchangeable graphics. Its X-shaped structure is made of fiberglass and plastic parts. Exhibitors can quickly assemble it in a few seconds (no tools required). It includes a nylon carry bag. Because of its 1200mm width they are suitable for joining multiple units as a photocall or a promotional wall.

VALORIA	QTY	N.W	G.W	C.B.M	SIZE
Packing	10	16kg	17kg	0.1170	1400x380x220mm
Uni.	1	1.60kg	1.70kg	0.008	200x30x1360mm
10.006	Graphic Size: 1200x1980mm				

VALORIA

1.2m Width

COFFEE

77



DISPLAY DETAILS



DISPLAY DETAILS

GRAPHIC ATTACHMENT BY EYELETS

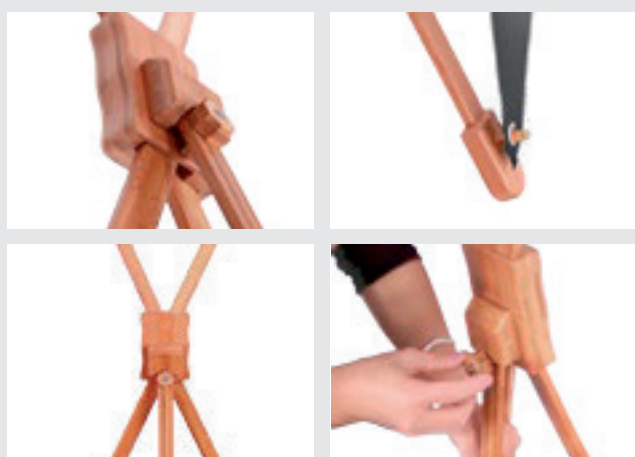

DIMENSIONS

*mm

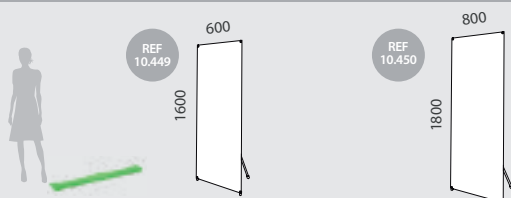

INFORMATION

The Bamboo X-Banner is a portable, detachable and lightweight display for interchangeable graphics. It is made of Bamboo Wood. Exhibitors can quickly assemble it in a few seconds (no tools required). A green nylon carry bag is included. Ideal for getting a touch of stylish and functional design.

BAMBOO 600	QTY	N.W	G.W	C.B.M	SIZE
Packing	40	20kg	22.50kg	0.13	450x270x130mm
Uni.	1	0.50kg	0.55kg	0.004	105x40x980mm

10.449 Graphic Size: 600x1600mm

BAMBOO 800	QTY	N.W	G.W	C.B.M	SIZE
Packing	40	34kg	36kg	0.15	280x450x180mm
Uni.	1	0.85kg	0.90kg	0.005	105x40x1100mm

10.450 Graphic Size: 800x1800mm

BAMBOO





L-BANNER

Display



DISPLAY DETAILS



INFORMATION

*mm

Mestanza L-Banner is a detachable and lightweight display for interchangeable graphics. Its stable L-shaped structure is easy to set-up. Exhibitors can quickly assemble it with 3 simple steps. Includes a carry bag.



MESTANZA	QTY	N.W	G.W	C.B.M	SIZE
Packing	25	10kg	11.25kg	0.073	300x230x1060mm
Uni.	1	0.40kg	0.45kg	0.004	140x30x1060mm
10.774	Graphic Size: 600x1600mm				

MESTANZA

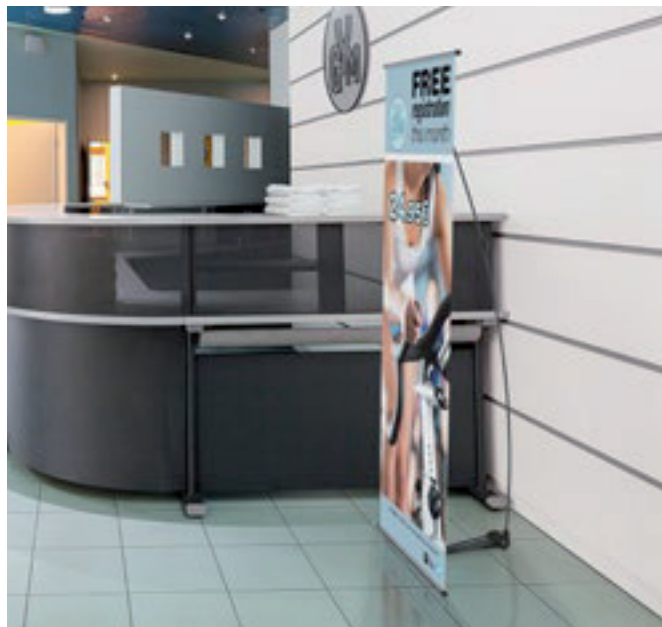

DISPLAY DETAILS



INFORMATION

*mm

Navas is a portable, detachable and lightweight display for interchangeable graphics. Its stable L-shape can quickly assemble in a few seconds (graphic is attached by adhesive) Includes a carry bag.

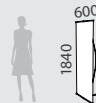

NAVAS	QTY	N.W	G.W	C.B.M	SIZE
Packing	20	14kg	20kg	0.081	340x240x1000mm
Uni.	1	0.70kg	1kg	0.012	110x110x930mm
10.001	Graphic Size: 600x1840mm				

NAVAS

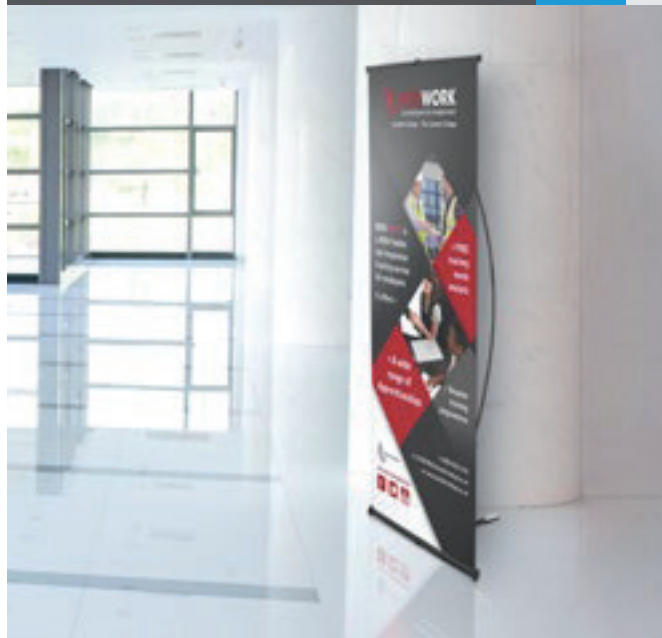

DISPLAY DETAILS



INFORMATION

*mm

Bonne L-Banner is a detachable and lightweight display for interchangeable graphics. It is made of aluminium and plastic. Its stable L-shaped structure (with 490mm depth) is very easy to set-up, so exhibitors can quickly assemble in only a few seconds (the graphic is attached by upper snap rail). Also, Bonn L-Banner includes a black nylon carry bag for a better transportation.

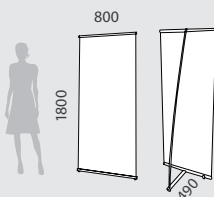

BONN



BONN	QTY	N.W	G.W	C.B.M	SIZE
Packing	10	11kg	12kg	0.0498	830x200x300mm
Uni.	1	1.10kg	1.20kg	0.023	200x125x950mm
10.575	Graphic Size: 800x1800mm				



ROLL-UP Display



DISPLAY DETAILS



DIMENSIONS

*mm

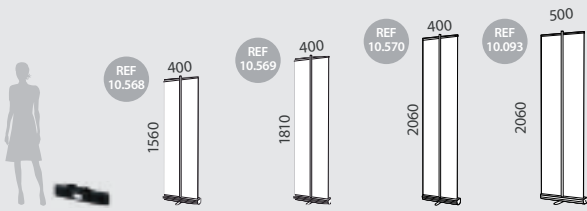

INFORMATION

Abadia Roll Up is a portable and lightweight display for interchangeable and retractable graphics. It is made of aluminium and plastic parts. Banner rolls up and down in seconds making setting up presentation quick and easy. It includes a carry bag for effortless transport. Abadia is ideal to display in front of columns.

ABADIA 1	QTY	N.W	G.W	C.B.M	SIZE
Packing	10	7.5kg	8kg	0.04	450x210x470mm
Uni.	1	0.75kg	0.80kg	0.003	95x95x430mm
10.568	Graphic Size: 400x1560mm				
ABADIA 2	QTY	N.W	G.W	C.B.M	SIZE
Packing	10	7.5kg	8kg	0.04	450x210x470mm
Uni.	1	0.75kg	0.80kg	0.003	95x95x430mm
10.569	Graphic Size: 400x1810mm				
ABADIA 3	QTY	N.W	G.W	C.B.M	SIZE
Packing	10	7.5kg	8kg	0.04	450x210x470mm
Uni.	1	0.75kg	0.80kg	0.003	95x95x430mm
10.570	Graphic Size: 400x2060mm				
ABADIA 4	QTY	N.W	G.W	C.B.M	SIZE
Packing	10	15kg	17kg	0.06	485x230x600mm
Uni.	1	1.5kg	1.7kg	0.004	95x95x550mm
10.093	Graphic Size: 500x2060mm				

ABADIA



“
Ideal for being used in front of columns
”

DISPLAY DETAILS



DIMENSIONS

*mm

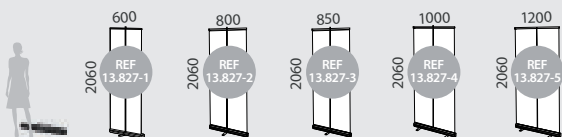

INFORMATION

Torino features a kit of accessories (sold separately) which allow you to join together with another Torino and get a 2-sided view. Set up is easy, just line up the 2 Units, connect the bases, raise the banners and connect them at top. Carry bag included.

600x2060	QTY	N.W	G.W	C.B.M	SIZE
Packing	10	12.7kg	13.5kg	0.04	430x170x650mm
Uni.	1	1.27kg	1.35kg	0.005	90x90x625mm
13.827-600	Graphic Size: 600x2060mm				
800x2060	QTY	N.W	G.W	C.B.M	SIZE
Packing	10	17kg	18kg	0.06	430x170x850mm
Uni.	1	1.7kg	1.8kg	0.006	90x90x825mm
13.827-800	Graphic Size: 800x2060mm				
850x2060	QTY	N.W	G.W	C.B.M	SIZE
Packing	10	19kg	20kg	0.06	430x170x900mm
Uni.	1	1.9kg	2kg	0.007	90x90x875mm
13.827-850	Graphic Size: 850x2060mm				
1000x2060	QTY	N.W	G.W	C.B.M	SIZE
Packing	10	21kg	22kg	0.07	430x170x1050mm
Uni.	1	2.1kg	2.2kg	0.008	90x90x1025mm
13.827-1000	Graphic Size: 1000x2060mm				
1200x2060	QTY	N.W	G.W	C.B.M	SIZE
Packing	10	25kg	26kg	0.09	430x170x1250mm
Uni.	1	2.5kg	2.6kg	0.009	90x90x1225mm
13.827-1200	Graphic Size: 1200x2060mm				

DOUBLE-SIDED ACCESSORIES KIT



ACCESSORIES	QTY	N.W	G.W	C.B.M	SIZE
Packing	10	4.5kg	5kg	0.017	430x220x180mm
Uni.	1	0.45kg	0.47kg	0.0057	250x150x150mm
13.828	Double Side Accessories Kit				

TORINO



DISPLAY DETAILS



DIMENSIONS

*mm

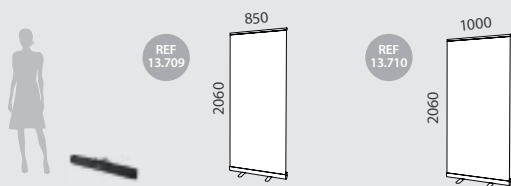

INFORMATION

The Sidney Roll Up is a quick yet economical solution for your business presentation needs. It features metal connections at base feet and also, an improved stability thanks its special joining pole piece. It is made of anodized aluminium and plastic parts. Also it includes a hand strap carry bag.

SIDNEY 850	QTY	N.W	G.W	C.B.M	SIZE
Packing	6	10.8kg	12kg	0.051	300x200x850mm
Uni.	1	1.8kg	2kg	0.007	90x90x875mm
13.709	Graphic Size: 850x2060mm				

SIDNEY 1000	QTY	N.W	G.W	C.B.M	SIZE
Packing	6	13.8kg	15kg	0.063	300x200x1050mm
Uni.	1	2.3kg	2.5kg	0.008	90x90x1040mm
13.710	Graphic Size: 1000x2060mm				

SIDNEY



“
The Roll Up design saves floor space
”

DISPLAY DETAILS



DIMENSIONS

*mm

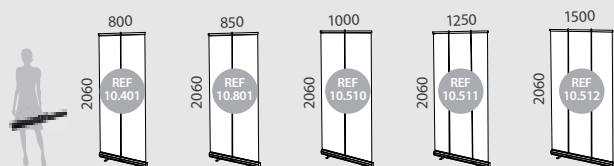

INFORMATION

Alcala Roll Ups features 5 widths available. It is made of aluminium and plastic parts. Banner rolls up and down in seconds making setting up presentation quick and easy. Also it includes a single oxford carry bag.

800x2060	QTY	N.W	G.W	C.B.M	SIZE
Packing	6	11.5kg	12kg	0.05	300x210x850mm
Uni.	1	1.91kg	2kg	0.006	90x90x840mm
10.401	Graphic Size: 800x2060mm				
850x2060	QTY	N.W	G.W	C.B.M	SIZE
Packing	6	12.5kg	13kg	0.06	300x210x900mm
Uni.	1	2.08kg	2.16kg	0.007	90x90x875mm
10.801	Graphic Size: 850x2060mm				
1000x2060	QTY	N.W	G.W	C.B.M	SIZE
Packing	6	14.5kg	15kg	0.07	300x210x1050mm
Uni.	1	2.41kg	2.5kg	0.008	90x90x1040mm
10.510	Graphic Size: 1000x2060mm				
1250x2060	QTY	N.W	G.W	C.B.M	SIZE
Packing	6	18.5kg	19kg	0.08	300x210x1300mm
Uni.	1	3.03kg	3.16kg	0.012	95x95x1270mm
10.511	Graphic Size: 1250x2060mm				
1500x2060	QTY	N.W	G.W	C.B.M	SIZE
Packing	6	20.5kg	21kg	0.10	300x210x1550mm
Uni.	1	3.41kg	3.50kg	0.013	100x95x1520mm
10.512	Graphic Size: 1500x2060mm				

ALCALA



“ Use optional spotlight for highlight your exhibitions (sold separately) ”

DISPLAY DETAILS



DIMENSIONS

*mm

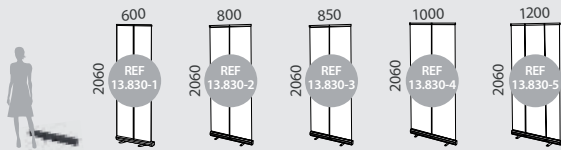

600x2060	QTY	N.W	G.W	C.B.M	SIZE
Packing	6	16.2kg	16.65kg	0.05	350x240x670mm
Uni.	1	2.70kg	2.77kg	0.009	110x110x650mm
13.830-600	Graphic Size: 600x2060mm				
800x2060	QTY	N.W	G.W	C.B.M	SIZE
Packing	6	19.9kg	20kg	0.07	350x240x670mm
Uni.	1	3.2kg	3.33kg	0.012	110x110x850mm
13.830-800	Graphic Size: 800x2060mm				
850x2060	QTY	N.W	G.W	C.B.M	SIZE
Packing	6	20.4kg	21kg	0.07	350x240x920mm
Uni.	1	3.4kg	3.5kg	0.012	110x110x900mm
13.830-850	Graphic Size: 850x2060mm				
1000x2060	QTY	N.W	G.W	C.B.M	SIZE
Packing	6	21.3kg	22.2kg	0.08	350x240x1070mm
Uni.	1	3.55kg	3.7kg	0.014	110x110x1050mm
13.830-1000	Graphic Size: 1000x2060mm				
1200x2060	QTY	N.W	G.W	C.B.M	SIZE
Packing	6	27.6kg	29.45kg	0.10	350x240x1270mm
Uni.	1	4.6kg	4.9kg	0.017	110x110x1250mm
13.830-1200	Graphic Size: 1200x2060mm				

ORLEANS



DISPLAY DETAILS



INFORMATION

Orleans is one of the best-selling Roll-Ups in the world. Featuring an extra weight aluminium structure with 10 sizes available. Banner rolls up and down in seconds making setting up presentation quick and easy. It includes a carry bag.

DIMENSIONS

*mm

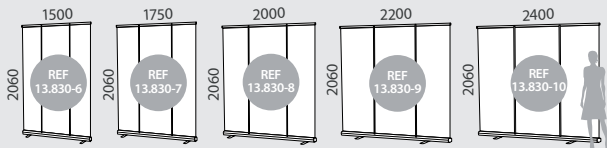

1500x2060	QTY	N.W	G.W	C.B.M	SIZE
Packing	4	22kg	23.4kg	0.09	250x250x1580mm
Uni.	1	5.5kg	5.85kg	0.024	120x120x1560mm
13.830-1500	Graphic Size: 1500x2060mm				
1750x2060	QTY	N.W	G.W	C.B.M	SIZE
Packing	2	11.8kg	12.3kg	0.05	130x250x1830mm
Uni.	1	5.9kg	6.15kg	0.029	120x120x1810mm
13.830-1750	Graphic Size: 1750x2060mm				
2000x2060	QTY	N.W	G.W	C.B.M	SIZE
Packing	2	13kg	14kg	0.06	130x250x2070mm
Uni.	1	6.5kg	7kg	0.033	120x120x2050mm
13.830-2000	Graphic Size: 2000x2060mm				
2200x2060	QTY	N.W	G.W	C.B.M	SIZE
Packing	2	14.6kg	15.4kg	0.07	130x250x2270mm
Uni.	1	7.3kg	7.7kg	0.036	120x120x2250mm
13.830-2200	Graphic Size: 2200x2060mm				
2400x2060	QTY	N.W	G.W	C.B.M	SIZE
Uni.	1	8.2kg	8.5kg	0.08	130x130x2470mm
13.830-2400	Graphic Size: 2400x2060mm				

ORLEANS



Use promotional counters for completing your exhibitions (sold separately)

DISPLAY DETAILS



DIMENSIONS

*mm

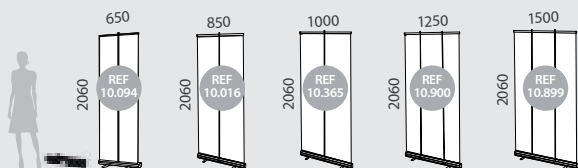

INFORMATION

The Alberca Roll Up features an extra weight aluminium structure with 5 widths available. Banner rolls up and down in seconds making setting up presentation quick and easy. Also it includes a double padded carry bag.

650x2060	QTY	N.W	G.W	C.B.M	SIZE
Packing	10	16kg	18kg	0.06	700x200x480mm
Uni.	1	1.6kg	1.8kg	0.005	95x95x650mm
10.094	Graphic Size: 650x2060mm				
850x2060	QTY	N.W	G.W	C.B.M	SIZE
Packing	6	17.5kg	18kg	0.07	320x230x900mm
Uni.	1	2.91kg	3kg	0.009	100x100x890mm
10.016	Graphic Size: 850x2060mm				
1000x2060	QTY	N.W	G.W	C.B.M	SIZE
Packing	6	19.5kg	20kg	0.08	320x230x1050mm
Uni.	1	3.5kg	3.33kg	0.011	100x100x1040mm
10.365	Graphic Size: 1000x2060mm				
1250x2060	QTY	N.W	G.W	C.B.M	SIZE
Packing	6	21.5kg	22kg	0.10	320x230x1300mm
Uni.	1	3.58kg	3.66kg	0.012	100x100x1300mm
10.900	Graphic Size: 1250x2060mm				
1500x2060	QTY	N.W	G.W	C.B.M	SIZE
Packing	6	23kg	24kg	0.11	320x230x1550mm
Uni.	1	3.83kg	4kg	0.015	100x100x1540mm
10.899	Graphic Size: 1500x2060mm				

ALBERCA

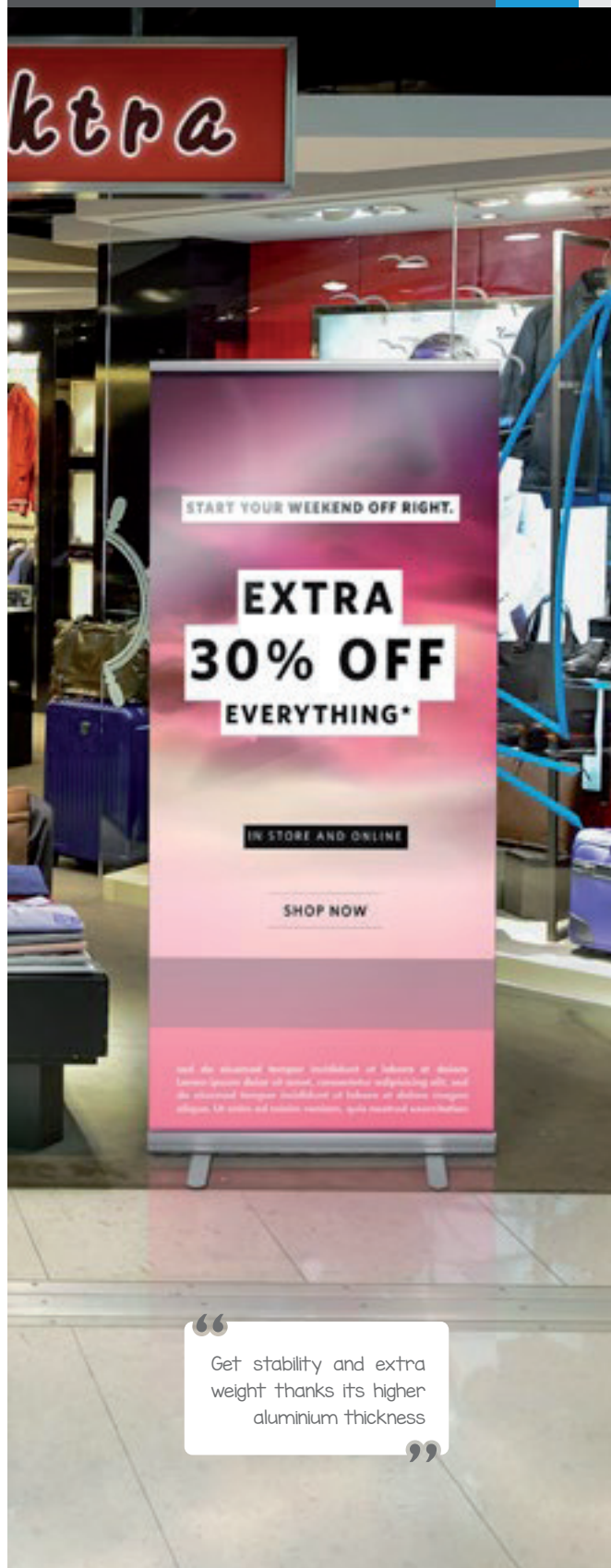

DISPLAY DETAILS



DIMENSIONS

*mm

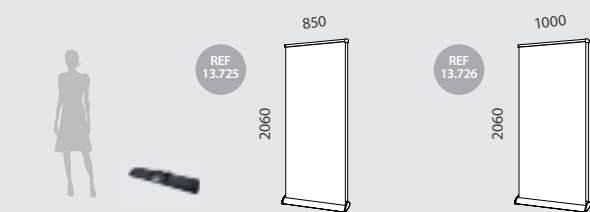

INFORMATION

Mora is a Double Sided Roll Up wich features 2 widths available (850mm or 1000mm). It is made of aluminium and plastic parts. Banner rolls up and down in seconds making setting up presentation quick and easy. Mora features a stable base with no-feet design with leveling feet. Also it includes a carry bag. Ideal for trade shows, expositions, retail stores or any media event.

MORA 850	QTY	N.W	G.W	C.B.M	SIZE
Packing	4	15.6kg	18.8kg	0.02727	890x190x430mm
Uni.	1	3.90kg	4.70kg	0.021	900x130x180mm
13.725	Graphic Size: 850x2060mm				

MORA 1000	QTY	N.W	G.W	C.B.M	SIZE
Packing	4	17.6kg	21kg	0.0850	1040x190x430mm
Uni.	1	4.40kg	5.25kg	0.024	1040x130x180mm
13.726	Graphic Size: 1000x2060mm				

MORA



DISPLAY DETAILS



DIMENSIONS

*mm

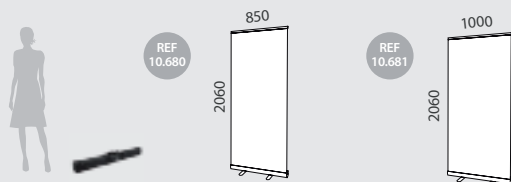

INFORMATION

This Roll Up features a full black finish and it is made of durably aluminum so it is incredibly lightweight and saves floor space. Easy change of graphic, set up is quick and easy, just connect the pole to the base, roll-up the graphic and hook it at the top of the pole. With canvas carry bag included. Ideal for trade shows, expositions, retail stores or any media event.

ALTEA 850	QTY	N.W	G.W	C.B.M	SIZE
Packing	10	22kg	24kg	0.093	490x210x910mm
Uni.	1	2.20kg	2.40kg	0.007	90x90x875mm
10.680	Graphic Size: 850x2060mm				

ALTEA 1000	QTY	N.W	G.W	C.B.M	SIZE
Packing	10	25kg	26kg	0.109	490x210x1060mm
Uni.	1	2.50kg	2.60kg	0.011	105x105x1040mm
10.681	Graphic Size: 1000x2060mm				

ALTEA



“ Use optional spotlight for highlight your exhibitions (sold separately) ”

* optional spotlight (sold apart, see later Roll Up accessories at Cap.1)

DISPLAY DETAILS



DIMENSIONS

*mm

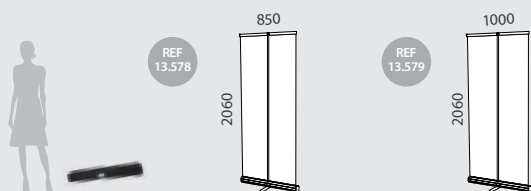

INFORMATION

This Roll Up banner is made of durably aluminum with plastic parts so it is incredibly lightweight and slim-line design that makes it visually appealing and saves floor space. Easy change of graphic, set up is quick and easy, users can simply connect the pole to the base, roll-up the graphic and hook the banner at the top of the pole. Additionally, a canvas carry bag is included. Ideal for trade shows, expositions, retail stores or any media event.

DUERO 850	QTY	N.W	G.W	C.B.M	SIZE
Packing	6	14.4kg	14.8kg	0.0786	320x270x910mm
Uni.	1	2.4kg	2.8kg	0.01	110x105x890mm
13.578	Graphic Size: 850x2060mm				

DUERO 1000	QTY	N.W	G.W	C.B.M	SIZE
Packing	6	16.8kg	17.4kg	0.0926	320x270x1060mm
Uni.	1	2.8kg	3.3kg	0.011	105x105x1040mm
13.579	Graphic Size: 1000x2060mm				

DUERO



DISPLAY DETAILS



DIMENSIONS

*mm

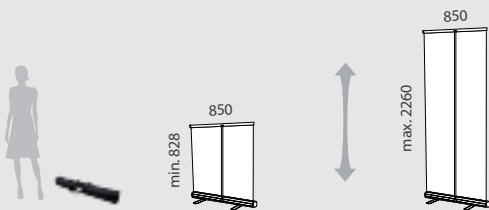

INFORMATION

This Roll Up banner is made of durably aluminum with plastic parts so it is incredibly lightweight and saves floor space. Featuring stylish open bases and adjustable height thanks to its telescopic pole. With an easy change of graphic, set up is quick and easy. Additionally, a canvas carry bag is included. Ideal for trade shows, expositions, retail stores or any media event.

DEHESA	QTY	N.W	G.W	C.B.M	SIZE
Packing	6	19.20kg	23kg	0.09	360x260x910mm
Uni.	1	3.15kg	3.50kg	0.01	110x110x900mm
10.020	Graphic Size: 850x828-2260mm				

DEHESA



“ Use promotional counters for completing your exhibitions (sold separately) ”

DISPLAY DETAILS



GRAPHIC CASSETTE EXCHANGE

DIMENSIONS

*mm

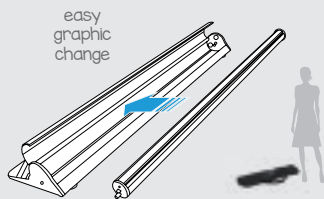

REF 13.829-1



REF 13.829-2



INFORMATION

Milano Roll Up is made of durably aluminum with plastic parts. It features an easy change of graphic thanks its unique design with a interchangeable cassette, graphic change is quick and easy, users can simply put the cassette into the base, roll-up the graphic and hook the banner at the top of the pole. Additionally, a canvas carry bag is included. Ideal for trade shows, expositions, retail stores or any media event.

MILANO 850	QTY	N.W	G.W	C.B.M	SIZE
Packing	4	16kg	17kg	0.07	300x260x920mm
Uni.	1	4kg	4.25kg	0.01	150x130x875mm
13.829-850	Graphic Size: 850x1640-2260mm				
MILANO 1000	QTY	N.W	G.W	C.B.M	SIZE
Packing	4	18kg	19kg	0.08	300x260x1000mm
Uni.	1	4.5kg	4.75kg	0.02	150x130x1025mm
13.829-1000	Graphic Size: 1000x1640-2260mm				

MILANO



“ With an comfortable and fast change of graphic thanks its interchangeable cassette. ”

DISPLAY DETAILS



DISPLAY DETAILS

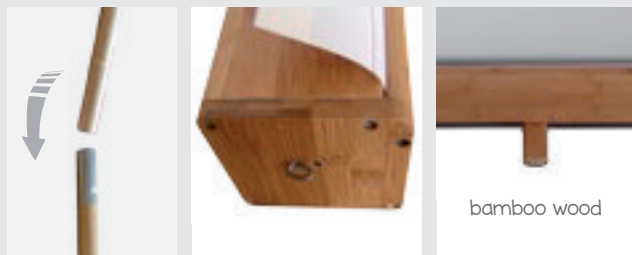

INFORMATION

*mm

This Roll Up is made of bamboo wood. Featuring stylish natural design. With an easy change of graphic, set up is quick and easy. A nylon carry bag is included. Ideal for trade shows, expositions, retail stores or any event.

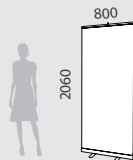

BAMBOO	QTY	N.W	G.W	C.B.M	SIZE
Packing	4	12.6kg	15.2kg	0.091	350x290x900mm
Uni.	1	3.15kg	3.80kg	0.02	170x140x870mm
10.444	Graphic Size: 800x2060mm				

BAMBOO



DISPLAY DETAILS



INFORMATION

DIMENSIONS

*mm

Cervera Luxury Roll Up features silver or black finish available. The aluminum design is durable, yet attractive and adds a stylish and luxurious touch. Cervera base has leveling feet and also, it includes a double padded carry bag.

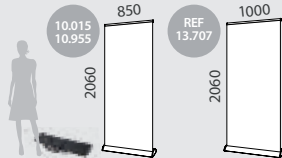

CERVERA 850	QTY	N.W	G.W	C.B.M	SIZE
Packing	4	17.4kg	20.6kg	0.083	890x190x430mm
Uni.	1	4.35kg	5.15kg	0.018	150x135x920mm
10.015	Graphic Size: 850x2060mm				

CERVERA 1000	QTY	N.W	G.W	C.B.M	SIZE
Packing	4	21.6kg	23.2kg	0.097	450x200x1080mm
Uni.	1	5.4kg	5.8kg	0.0216	150x135x1070mm
13.707	Graphic Size: 1000x2060mm				

CERVERA 850	QTY	N.W	G.W	C.B.M	SIZE
Packing	4	17.6kg	21kg	0.083	890x190x430mm
Uni.	1	4.4kg	5.25kg	0.018	150x135x920mm
10.955	Graphic Size: 850x2060mm				

CERVERA



“ Ideal for providing a distinguishing and stylish touch. ”

DISPLAY DETAILS



INFORMATION

*mm

Ribas Roll Up features silver finish available. Its unique design is durable, yet attractive and adds a stylish and luxurious touch. Its base has leveling feet and also it is double-sided so it can be used as a sidewalk stand (ideal for areas with 2-ways traffic). It includes a double padded carry bag.

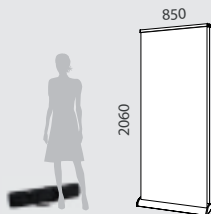

RIBAS

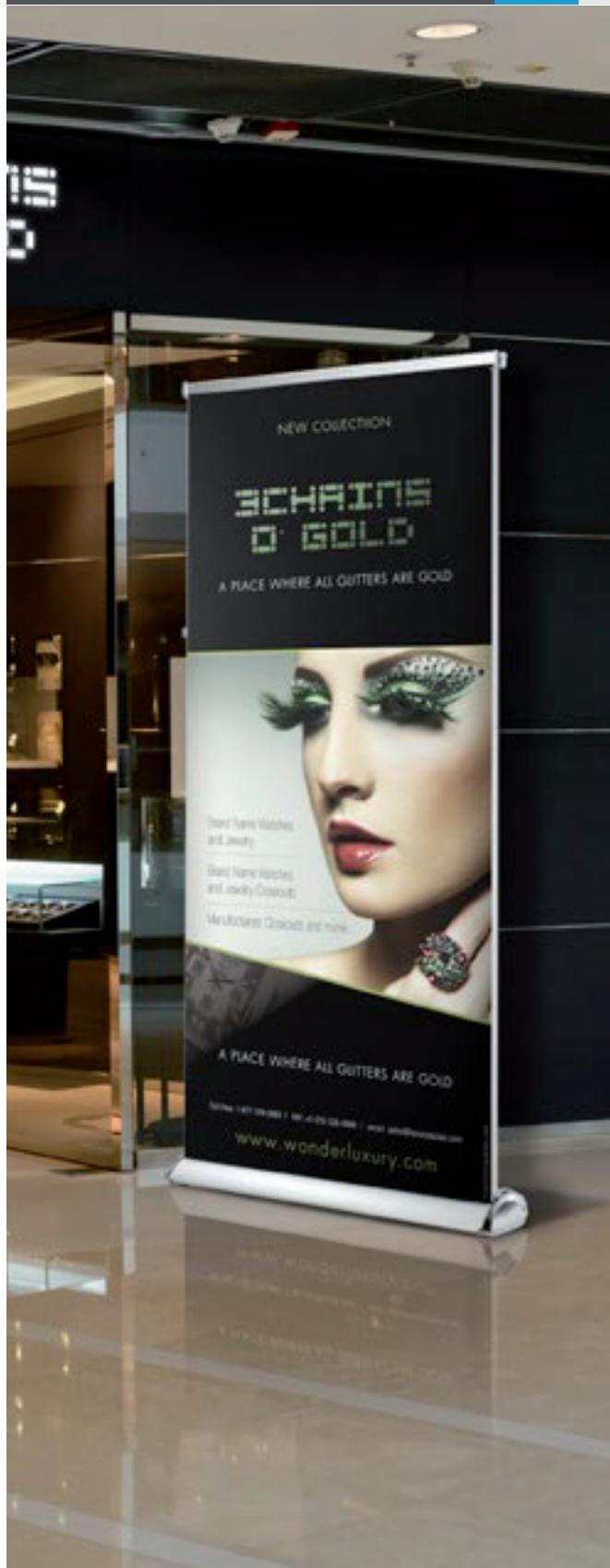

RIBAS	QTY	N.W	G.W	C.B.M	SIZE
Packing	4	22kg	26.6kg	0.16	530x300x980mm
Uni.	1	5.5kg	6.65kg	0.03	250x135x920mm
10.013	Graphic Size: 850x2060mm				

DISPLAY DETAILS



FLEX SYSTEM

*mm

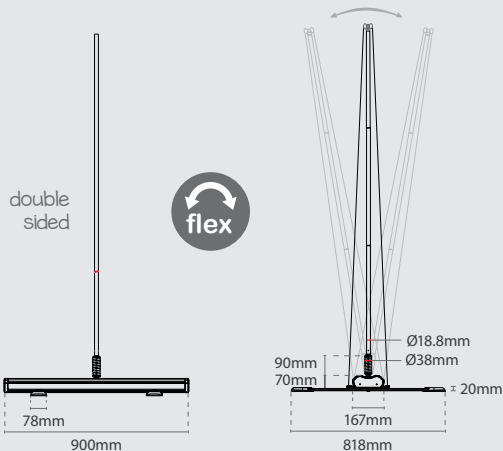

INFORMATION

*mm

This Roll Up features a silver aluminium finish. Ibiza is suitable for being used at outdoor or indoor and its design features a flex system for resisting windy conditions. Its base is holed for being used with 4 stakes (included). Also, it is 2-sided so it can be used as a sidewalk stand (ideal for areas with 2-ways traffic). It includes a double padded carry bag.



IBIZA



IBIZA	QTY	N.W	G.W	C.B.M	SIZE
Packing	1	7.6kg	8.8kg	0.03	300x110x930mm

10.447 Graphic Size: 850x2060mm

DISPLAY DETAILS

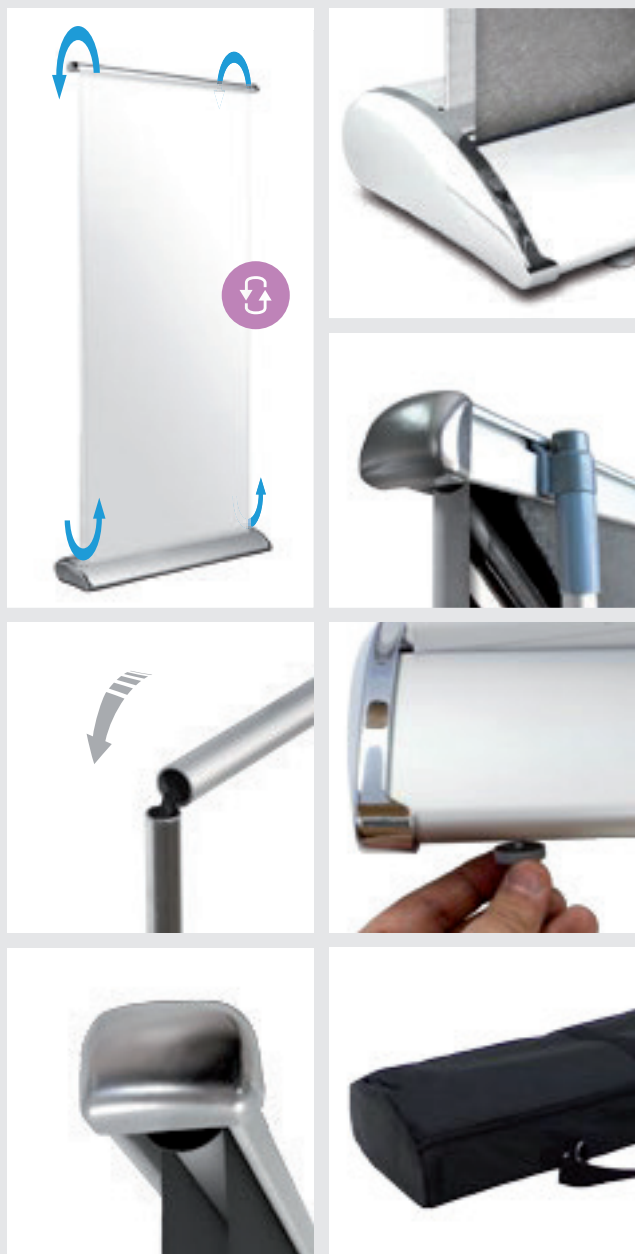

INFORMATION

*mm

Pineda Roll Up features an electrical scrolling design which allows to display a large 4105mm and continuous graphic banner. Its base has leveling feet and it includes a double padded carry bag. Pineda Scroll Roll Up is ideal for being used at conventions, tradeshows, expositions, business presentations or at any media event.

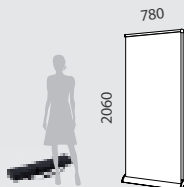

PINEDA	QTY	N.W	G.W	C.B.M	SIZE
Packing	4	19.80kg	24.60kg	0.16	530x300x980mm
Uni.	1	4.95kg	6.15kg	0.034	280x130x925mm
10.022	Graphic: 780x4105mm		Visible: 780x2060mm		

PINEDA SCROLL



DISPLAY DETAILS



INFORMATION

*mm

The Bremen Roll Up has a silver aluminium finish and it features a middle shelf for the displaying of promotional items or appetizers at tradeshows or conventions. Also, it has 2x A4 format trays for brochures or literature. It includes a double padded nylon carry bag.

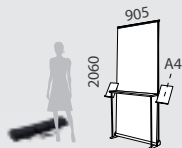

BREMEN	QTY	N.W	G.W	C.B.M	SIZE
Packing	1	6.30kg	6.95kg	0.037	250x150x990mm
10.826		Graphic Size: 905x2060mm			

BREMEN



DISPLAY DETAILS



INFORMATION

*mm

This Roll Up features a tablet holder (2 sizes available) whose frame allows a 360° rotation. Also, it has lock for safety use. It includes a double padded carry bag. Pineda Scroll Roll Up is ideal for conventions, tradeshows, expositions, media events or any business presentation.

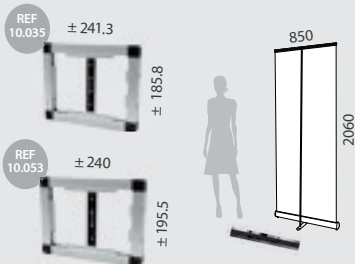

TABLET HOLDER 1	QTY	N.W	G.W	C.B.M	SIZE
Packing	1	0.75kg	0.90kg	0.003	260x47x310mm
		3.60kg	4.10kg	0.013	130x110x930mm

10.035 Roll Up Graphic Size: 850x2060mm
Size for Tablets: ±185.8x241.3mm

TABLET HOLDER 2	QTY	N.W	G.W	C.B.M	SIZE
Packing	1	0.75kg	0.90kg	0.003	260x47x310mm
		3.60kg	4.10kg	0.013	130x110x930mm

10.053 Roll Up Graphic Size: 850x2060mm
Size for Tablets: ±195.5x240mm

TABLET HOLDER ROLL UP



* tablet is not included

DISPLAY DETAILS



DIMENSIONS

*mm

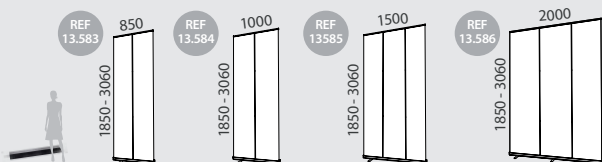

INFORMATION

The Nepal Roll Up banner is made of durably aluminum with plastic parts and features an adjustable height up to 3m. Set up is quick and easy and users can adjust the height tilting lowering the Roll Up Banner. A Nylon Carry bag is included. Ideal for trade shows, convention centers, malls, expositions, retail stores or any media event where their large graphics can be seen from at the distance. There are 4 widths available.

NEPAL 850	QTY	N.W	G.W	C.B.M	SIZE
Packing	6	24kg	25kg	0.098	380x280x920mm
Uni.	1	4kg	4.2kg	0.0145	125x130x895mm
13.583	Graphic Size: 850x1850-3060mm				
NEPAL 1000	QTY	N.W	G.W	C.B.M	SIZE
Packing	6	28.2kg	29kg	0.1138	380x280x1070mm
Uni.	1	4.7kg	4.83kg	0.017	125x130x1050mm
13.584	Graphic Size: 1000x1850-3060mm				
NEPAL 1500	QTY	N.W	G.W	C.B.M	SIZE
Packing	2	13.8kg	15kg	0.064	270x150x1580mm
Uni.	1	6.9kg	7.5kg	0.025	125x130x1565mm
13.585	Graphic Size: 1500x1850-3060mm				
NEPAL 2000	QTY	N.W	G.W	C.B.M	SIZE
Uni.	1	9.5kg	11kg	0.0468	150x150x2080mm
13.586	Graphic Size: 2000x1850-3060mm				

NEPAL



DISPLAY DETAILS

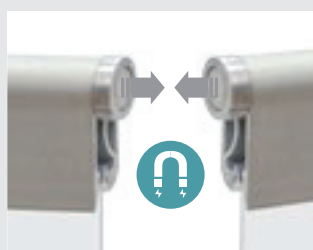

INFORMATION

DIMENSIONS

*mm

The Everest Roll Up banner is made of durable aluminum with magnetic side connection parts, featuring 3m height. At the top of each banner stand, there are patented magnetic connectors that allow you to join together multiple units with a simple "click". Because of its size, it is a great alternative to pop up displays and trade show booths. Set up is quick and easy, and users can adjust the height tilting lowering the Roll Up Banner. Additionally, a canvas carry bag is included. This Roll Up makes a great graphic mural in trade show booths, in press conferences, convention centers, in malls, expositions, retail stores or any other media event.

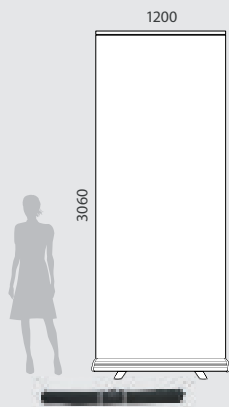

EVEREST	QTY	N.W	G.W	C.B.M	SIZE
Packing	6	40.2kg	45kg	0.15	420x290x1260mm
Uni.	1	6.50kg	7.30kg	0.018	120x120x1260mm
10.861	Graphic Size: 1200x3060mm				

EVEREST

3m High



“Join it with other Everest Roll Up for creating a photocal presentation”

ROLL UP BANNER LARGE RESIST Large Roll Up

DISPLAY DETAILS



DIMENSIONS

*mm

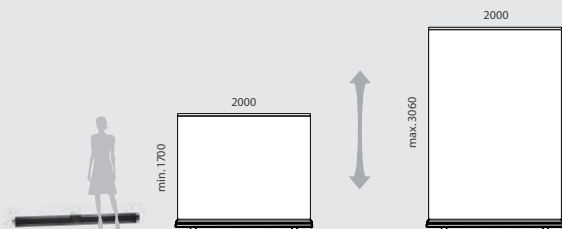

INFORMATION

If you are looking for something bigger, the Mont Blanc Roll Up Banner is 2000mm wide, featuring an adjustable height up to 3060mm. It is the perfect alternate to a trade show booth or pop up display. Due to its large height, assembly is easiest when you set up along the floor and then stand the display up. Also thanks to its telescopic capacity, the roll up Mont Blanc can be used in any other smaller places, with a minimum height of 1700mm. It comes with a carrying bag. It is perfect for trade shows, convention centers, for press conferences, expositions or for media events.

MONT BLANC	QTY	N.W	G.W	C.B.M	SIZE
Packing	1	13kg	14.80kg	0.061	180x160x2120mm
10.441	Graphic Size: 2000x1700-3060mm				

MONT BLANC

XL



ROLL UP BANNER LARGE RESIST ✂ 📦 Large Roll Up

DISPLAY DETAILS

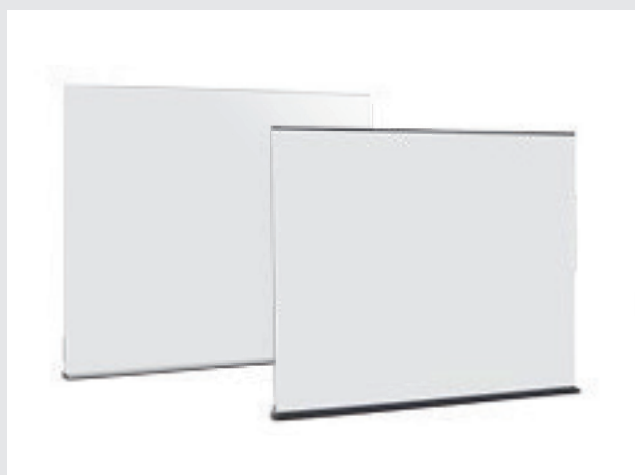

INFORMATION

DIMENSIONS

*mm

Max Elda is the widest Roll Up, made of sturdy aluminium features 2 different widths, 2400 and 3200mm. Silver and black finish is available. Additionally, it includes a canvas carry nylon bag.

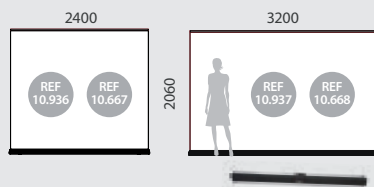

2400 SILVER	QTY	N.W	G.W	C.B.M	SIZE	
Packing	2	21.2kg	26.6kg	0.189	320x230x2580mm	
Uni.	1	10.6kg	13.3kg	0.071	320x90x2480mm	
10.936	Graphic Size: 2400x2060mm					
3200 SILVER	QTY	N.W	G.W	C.B.M	SIZE	
Packing	2	22kg	30.1kg	0.253	320x230x440mm	
Uni.	1	11kg	15.05kg	0.096	320x90x3340mm	
10.937	Graphic Size: 3200-2060mm					
2400 BLACK	QTY	N.W	G.W	C.B.M	SIZE	
Packing	2	21.2kg	26.6kg	0.189	320x230x2580mm	
Uni.	1	10.6kg	13.3kg	0.071	320x90x2480mm	
10.667	Graphic Size: 2400x2060mm					
3200 BLACK	QTY	N.W	G.W	C.B.M	SIZE	
Packing	2	22kg	30.1kg	0.253	320x230x440mm	
Uni.	1	11kg	15.05kg	0.096	320x90x3340mm	
10.668	Graphic Size: 3200x2060mm					

MAX ELDA



* optional counter (sold apart, see later in Events chapter)

BAG DETAILS



INFORMATION

*mm

- One side zipped. With Id Pocket.
- Shoulder and hand strap.



850 | 1000 | 1250 | 1500

SINGLE 850	QTY	N.W	G.W	C.B.M	SIZE
------------	-----	-----	-----	-------	------

Packing	1	0.12kg	0.22kg	0.0035	120x30x980mm
---------	---	--------	--------	--------	--------------

13.461 For Roll Up 850mm

SINGLE 1000	QTY	N.W	G.W	C.B.M	SIZE
-------------	-----	-----	-----	-------	------

Packing	1	0.15kg	0.25kg	0.0037	120x30x1030mm
---------	---	--------	--------	--------	---------------

13.462 For Roll Up 1000mm

SINGLE 1250	QTY	N.W	G.W	C.B.M	SIZE
-------------	-----	-----	-----	-------	------

Packing	1	0.17kg	0.30kg	0.0046	120x30x1300mm
---------	---	--------	--------	--------	---------------

13.433 For Roll Up 1250mm

SINGLE 1500	QTY	N.W	G.W	C.B.M	SIZE
-------------	-----	-----	-----	-------	------

Packing	1	0.50kg	0.70kg	0.0074	120x40x1550mm
---------	---	--------	--------	--------	---------------

13.778 For Roll Up 1500mm



SINGLE OXFORD BAG



BAG DETAILS



INFORMATION

*mm

- Zipper on one side. With ID Pocket.
- Shoulder and hand strap. Double padded



500 | 650 | 850 | 1000

DOUBLE 500	QTY	N.W	G.W	C.B.M	SIZE
------------	-----	-----	-----	-------	------

Packing	1	0.20kg	0.40kg	0.00288	120x40x600mm
---------	---	--------	--------	---------	--------------

13.494 For Roll Up 500mm

DOUBLE 650	QTY	N.W	G.W	C.B.M	SIZE
------------	-----	-----	-----	-------	------

Packing	1	0.28kg	0.50kg	0.0036	120x40x750mm
---------	---	--------	--------	--------	--------------

13.495 For Roll Up 650mm

DOUBLE 850	QTY	N.W	G.W	C.B.M	SIZE
------------	-----	-----	-----	-------	------

Packing	1	0.40kg	0.60kg	0.0047	120x40x980mm
---------	---	--------	--------	--------	--------------

13.463 For Roll Up 850mm

DOUBLE 1000	QTY	N.W	G.W	C.B.M	SIZE
-------------	-----	-----	-----	-------	------

Packing	1	0.50kg	0.70kg	0.0049	120x40x1030mm
---------	---	--------	--------	--------	---------------

13.464 For Roll Up 1000mm

DOUBLE PADDED BAG



BAG DETAILS



INFORMATION

*mm

- All crossed zipped.
- Shoulder and hand strap.
- With transparent pocket for ID Tag.



850 | 1000

D.P.ZIPPED 850	QTY	N.W	G.W	C.B.M	SIZE
----------------	-----	-----	-----	-------	------

Packing	1	0.40kg	0.60kg	0.004	120x40x980mm
---------	---	--------	--------	-------	--------------

13.459 For Roll Up 850mm

D.P.ZIPPED 1000	QTY	N.W	G.W	C.B.M	SIZE
-----------------	-----	-----	-----	-------	------

Packing	1	0.50kg	0.70kg	0.004	120x40x1030mm
---------	---	--------	--------	-------	---------------

13.460 For Roll Up 1000mm

DOUBLE PADDED ZIPPED BAG



“ Get an optimal protection for your Roll Up ”

* Roll Up not included / Roll Up non inclus / Roll Up não incluídos / Roll Up no incluidos.

SPOTLIGHT DETAILS



INFORMATION

*mm

Spotlights for Roll Up with Plug-in base at top the pole. Bulb type Halogen (included) and directional head, large luminous capacity. Spotlight works directly plugged in. Black or matt aluminium finish.



PLUG-IN SPOTLIGHT FOR ROLL UP



SPOTLIGHT DETAILS



INFORMATION

*mm

LED light spotlight with clamp adjustment for Roll Up. Works directly plugged in. Chrome finish and 12w LED light. With clamp for quick and easy use.

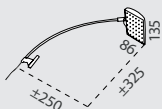

LED CLAMP SPOTLIGHT FOR ROLL UP



SPOTLIGHT DETAILS



INFORMATION

*mm

60w halogen bulb included. Telescopic (adjustable length). With 2 adapters for tops of the pole (plug-in and cap bases). Ideal to fit most Roll Ups on market. Large luminous capacity.

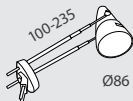

TELESCOPIC SPOTLIGHT FOR ROLL UP



TELESCOPIC	QTY	N.W	G.W	C.B.M	SIZE
Packing	1	0.30kg	0.35kg	0.0016	125x65x200mm
10.525				60 w	

* Roll Up not included.

HANGER DETAILS

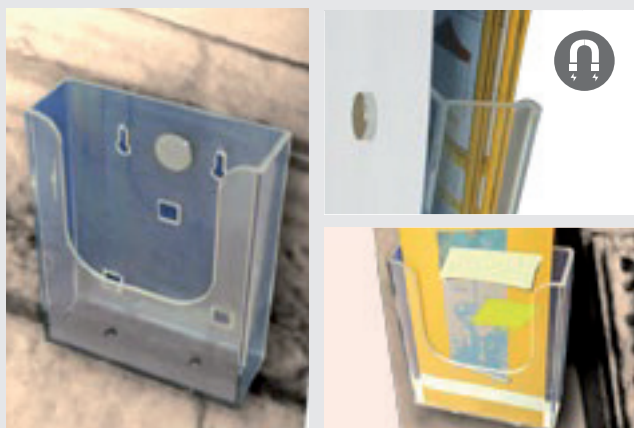

INFORMATION

*mm

Acrylic Brochure Holder for A6 leaflet size. Double magnet fixing system. No tools required. Ideal for any Roll Up.

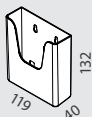

MAGNET DISPENSER	QTY	N.W	G.W	C.B.M	SIZE
Packing	5	0.85kg	0.95kg	0.004	165x130x215mm 
10.860	Graphic Size: A6		x5 		

MAGNETIC BROCHURE HOLDER



BAG FOR SPOTLIGHT ROLL UP

BAG DETAILS

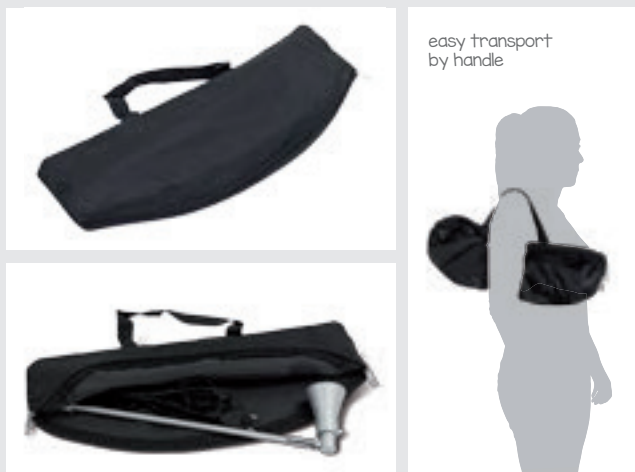

INFORMATION

*mm

The Oxford Bag is made of black nylon and all crossed zipped. It protects and extends the life of your Roll Up Spotlights. Easy transport by handle.

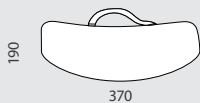

OXFORD BAG	QTY	N.W	G.W	C.B.M	SIZE
Packing	1	0.10kg	0.20kg	0.002	190x30x370mm
13.454					

GRAPHIC CASE

CASE DETAILS

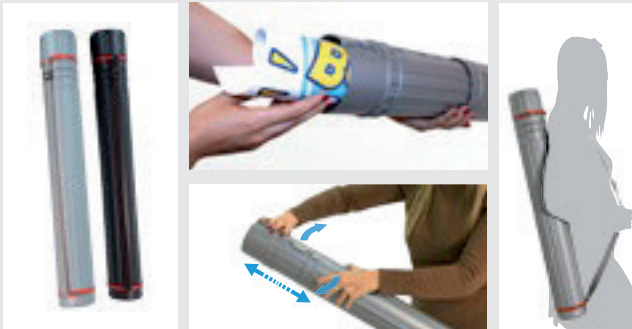

INFORMATION

Graphics case made of sturdy PVC. Features a shoulder strap for better carrying. Available in two colours (black and grey) and three different sizes.

GRAPHIC CASE 1	QTY	N.W	G.W	C.B.M	SIZE
Uni.	1	0.4kg	0.42kg	0.006	100x100x640mm
10.074		Ø107mm 640-1070mm			
10.075					
GRAPHIC CASE 2	QTY	N.W	G.W	C.B.M	SIZE
Uni.	1	0.5kg	0.52kg	0.008	100x100x780mm
10.076		Ø107mm 779-1280mm			
10.077					
GRAPHIC CASE 3	QTY	N.W	G.W	C.B.M	SIZE
Uni.	1	0.3kg	0.32kg	0.004	80x60x630mm
10.078		Ø85mm 630-1070mm			
10.079					

* Roll Up not included / Roll Up non inclus / Roll Up não inclusos / Roll Up no inclusos.

DISPLAY DETAILS



INFORMATION

Re-writable and erasable Led Board, Daganzo is available in A4 and A5 format. Featuring 12 modes of bright Neon Effects. It includes rechargeable battery, marker and screen eraser. Daganzo is ideal for promoting upcoming shows, special offers, dinners, special drinks at your bar or restaurant, or at party drawing as notice board and more.

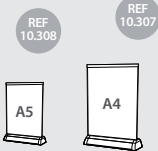

DAGANZO A5	QTY	N.W	G.W	C.B.M	SIZE
Packing	40	7.6kg	15.6kg	0.1	440x420x530mm
Uni.	1	0.19kg	0.39kg	0.003	170x100x220mm
10.308	Graphic Size: A5				
DAGANZO A4	QTY	N.W	G.W	C.B.M	SIZE
Packing	20	13.0kg	26.0kg	0.09	480x360x540mm
Uni.	1	0.65kg	1.30kg	0.05	260x100x340mm
10.307	Graphic Size: A4				

DAGANZO
LED WRITING BOARD

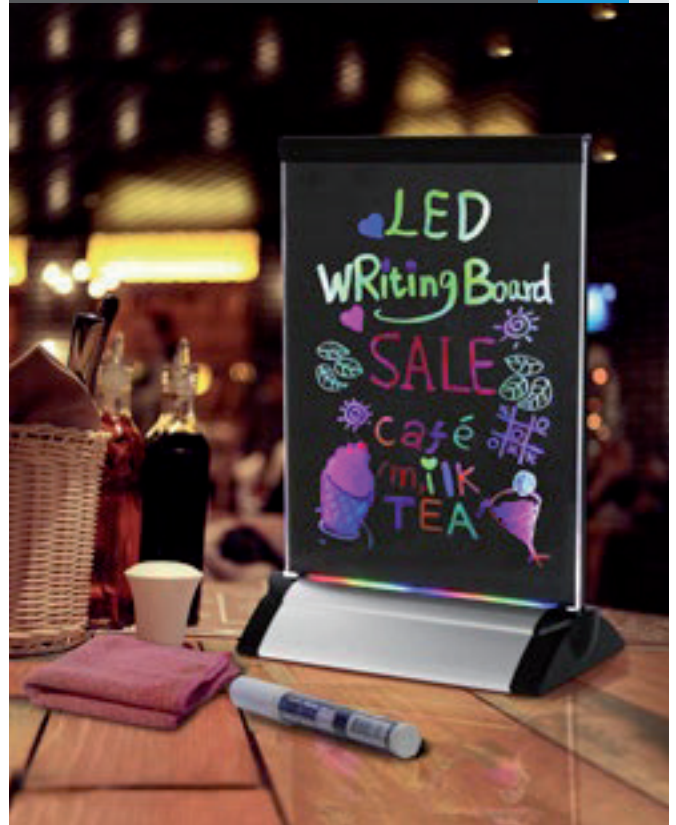

DISPLAY DETAILS



INFORMATION

This portable and retractable display for interchangeable graphics is made of aluminium and plastic parts. It is available in 2 sizes: A3 and A4. Ideal for promoting, special offers or for promoting business.



TORRICO A4	QTY	N.W	G.W	C.B.M	SIZE
Packing	50	15kg	17kg	0.0656	525x250x500mm
Uni.	1	0.3kg	0.4kg	0.001	90x45x260mm
10.787	Graphic Size: A4				
TORRICO A3	QTY	N.W	G.W	C.B.M	SIZE
Packing	50	17.5kg	19kg	0.0881	705x250x500mm
Uni.	1	0.35kg	0.6kg	0.0014	90x45x345mm
10.786	Graphic Size: A3				

TORRICO
MINI ROLL UP



DISPLAY DETAILS



INFORMATION *mm

Mini Flying Banner with steel base and fiberglass flag pole. It is recommendable to print the graphic part on textile. Ideal for promotional use on counters or desks. Graphic printing not included.



KRAKOW	QTY	N.W	G.W	C.B.M	SIZE
Packing	1	0.30kg	0.35kg	0.0003	30x12x850mm
10.596	Graphic Size: 550mm (Height)				

KRAKOW
MINI FLYING



DISPLAY DETAILS



INFORMATION *mm

Mini X-Banner with fiberglass structure and plastic parts. It offers the possibility of exchanging the graphics easily. Ideal for promotional use on counters or desks.



TORDESILLAS	QTY	N.W	G.W	C.B.M	SIZE
Packing	200	10kg	14kg	0.07	380x140x500mm
Uni.	1	0.05kg	0.05kg	0.00045	45x35x285mm
10.009	Graphic Size: 220x400mm				

TORDESILLAS
MINI X-BANNER



DISPLAY DETAILS



INFORMATION

*mm

Double sided banner display made of durable aluminium and plastic parts. Easy to assemble and graphic change. Carry bag is included. Ideal for trade shows, expositions, retail stores or any media event.

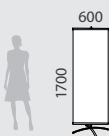

TORMES	QTY	N.W	G.W	C.B.M	SIZE
Packing	10	14.50kg	18kg	0.08	340x240x980mm
Uni.	1	1.45kg	1.80kg	0.007	85x85x930mm
10.010	Graphic Size: 600x1700mm				

TORMES CROSS BANNER



DISPLAY DETAILS



INFORMATION

*mm

Double sided banner display made of durable aluminium and plastic parts. Easy to assemble and graphic change. Carry bag is included. Ideal for trade shows, expositions, retail stores or any media event.

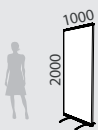

ALMEIDA	QTY	N.W	G.W	C.B.M	SIZE
Packing	10	26kg	29kg	0.11	340x240x1280mm
Uni.	1	2.60kg	2.90kg	0.014	120x100x1170mm
10.708	Graphic Size: 1000x2000mm				

ALMEIDA CROSS BANNER



DISPLAY DETAILS



INFORMATION

*mm

Triple sided banner display made of durable aluminium structure and plastic parts. Easy to assemble and change graphics. Carry bag is included.



GALENDE	QTY	N.W	G.W	C.B.M	SIZE
Packing	5	14kg	16kg	0.064	400x150x1080mm
Uni.	1	2.65kg	3.05kg	0.016	160x160x650mm
10.012	Graphic Size: 915x2150mm (x3)				

GALENDE TRIPLE BANNER



DISPLAY DETAILS



INFORMATION

This display features 4 folding sections for storage with 8 double sided panels (total one side: 2400x1800mm). Included carrying bag for an easy transporting. Grey RAL 9006 color.

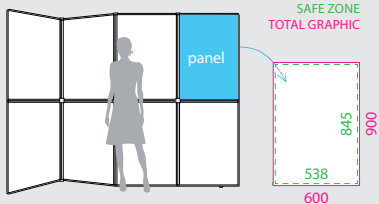

ARENAS	QTY	N.W	G.W	C.B.M	SIZE
Packing	1	7.3kg	11kg	0.12	640x200x950mm
10.041	Graphic Size: 2400x1800mm				

ARENAS EXHIBITION WALL



DISPLAY DETAILS



DIMENSIONS *mm

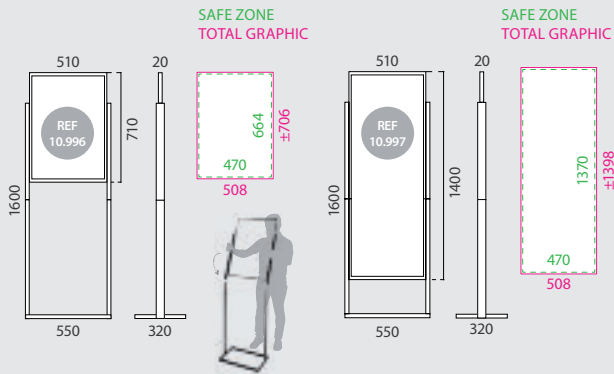
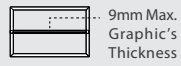

INFORMATION

These solid Displays are made of steel and they are black painted, featuring two different graphic size available. Slide the poster (9mm max. thickness) into the groove and display it back-to-back in high traffic areas.

STEEL D 1	QTY	N.W	G.W	C.B.M	SIZE
Packing	1	10.03kg	11.20kg	0.066	570x145x805mm
10.996	Graphic Size: 508 x ±706mm				
STEEL D 2	QTY	N.W	G.W	C.B.M	SIZE
Packing	1	11.30kg	12.47kg	0.066	570x145x805mm
10.997	Graphic Size: 508 x ±1398mm				

STEEL STAND DISPLAY



DISPLAY DETAILS



DIMENSIONS

ARTWORK *mm

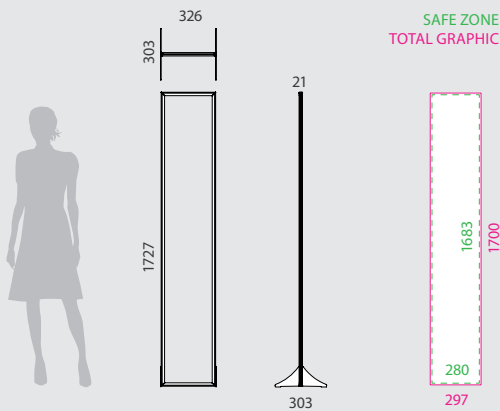

INFORMATION

Aluminium Banner Display is lacquered in gray RAL 9006 and features an easy to load and upload system. With an easy glide for the 1700mm height graphic poster (5mm max.thickness) into the metal grooves of the structure and display it back-to-back in high traffic areas. This Aluminium Banner Display is ideal for displaying at mall's corridors, for promoting at trade shows, outside your office or showroom.

A.BANNERD.	QTY	N.W	G.W	C.B.M	SIZE
Packing	1	1.8kg	2.32kg	0.0205	1745x335x35mm
13.643	Graphic Size: 297x1700mm				

ALUMINIUM BANNER DISPLAY

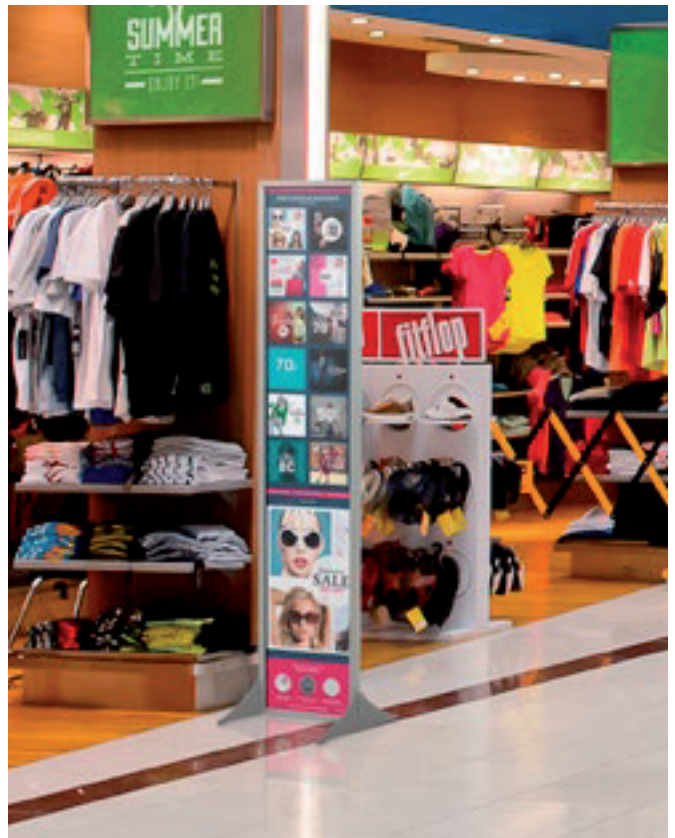
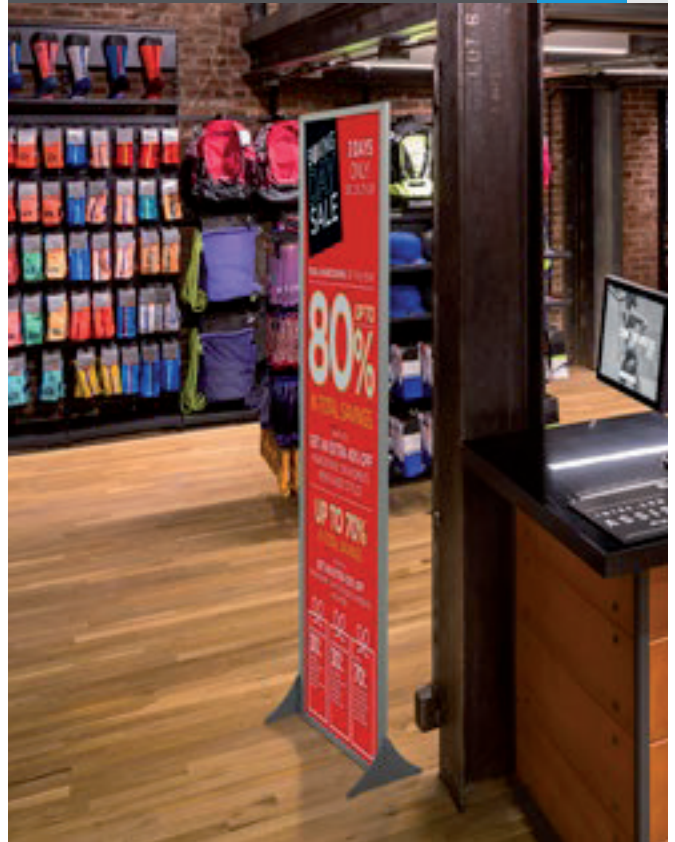

ALUMINIUM STAND DISPLAY

DISPLAY DETAILS

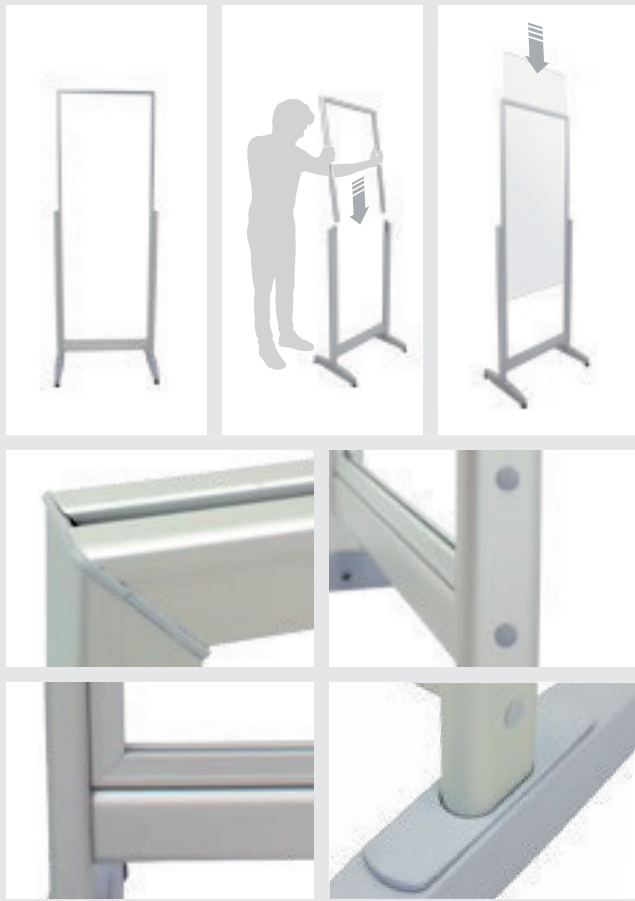

DIMENSIONS

ARTWORK *mm

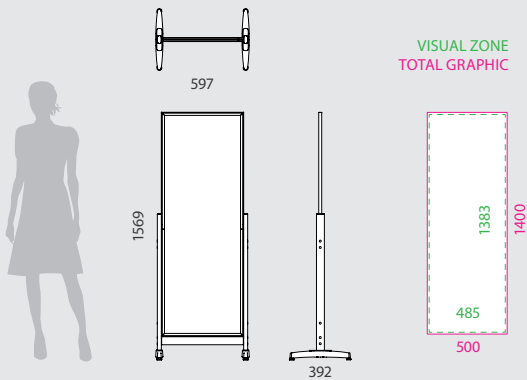

INFORMATION

Aluminium Stand Display lacquered in gray RAL 9006, featuring an easy to load and upload system. With adjustable stability sturdy feet and an easy glide for the 1400mm height graphic poster (9mm max.thickness) into the metal grooves of the structure and display it back-to-back. Ideal for promoting at trade shows, retail stores, fair stands, showrooms, travel agencies or offices.

A STAND D.	QTY	N.W	G.W	C.B.M	SIZE
Packing	1	4.47kg	5.54kg	0.0436	880x660x75mm
13.736	Graphic Size: 500x1400mm				



DISPLAY DETAILS



DIMENSIONS

*mm

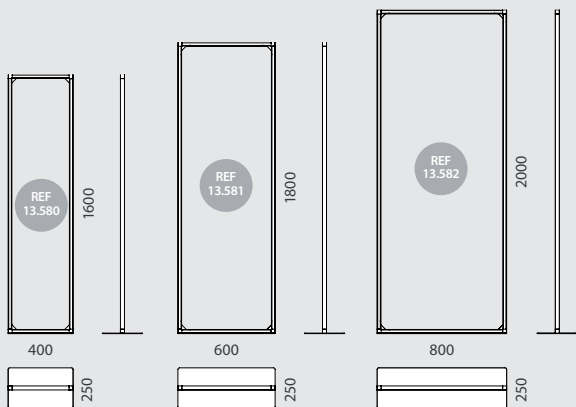

INFORMATION

This closed frame support is made of aluminium and it is suitable for PVC graphic posters, fixed with magnetic tape. Also, it features a stylish and sturdy flat base. Media Frame is ideal for using during a variety of promotional events, such as a trade shows, media events, exhibitions or even as solution for a photocall.

MEDIA F.	QTY	N.W	G.W	C.B.M	SIZE
Packing	1	7.5kg	8kg	0.0178	410x860x60mm
13.580	Graphic Size: 400x1600mm				
MEDIA F.	QTY	N.W	G.W	C.B.M	SIZE
Packing	1	10kg	11kg	0.0295	610x950x60mm
13.581	Graphic Size: 600x1800mm				
MEDIA F.	QTY	N.W	G.W	C.B.M	SIZE
Packing	1	13kg	14kg	0.0436	1070x810x60mm
13.582	Graphic Size: 800x2000mm				

MEDIA FRAME



* PVC sheet and magnetic tape not included.

DISPLAY DETAILS



DIMENSIONS

ARTWORK

*mm

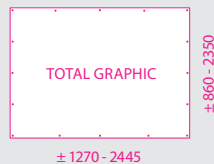
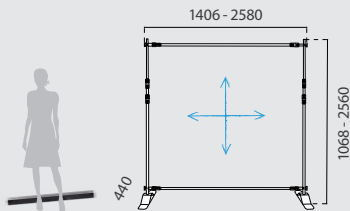

INFORMATION

With structure made of steel and black laquered. This portable and double-sided banner is ideal for using during a variety of promotional events, such as a trade show, media event, tradeshow exposition or even as solution for a photocall. Each pipe is also designed for an easy and fast telescopic adjustment of the display, allowing the use of graphs of different widths and heights. Vilamoura banner is a display fast to assemble and easy to transport. Adjustable height and width structure. Minimum graphic size: \pm Height 860 x Width 1270mm. Maximum graphic size: \pm Height 2350 x Width 2445mm.

VILAMOURA	QTY	N.W	G.W	C.B.M	SIZE
Packing	2	11kg	12kg	0.031	140x170x1380mm
Uni.	1	5.5kg	6kg	0.015	70x170x1380mm
10.498		Graphic Size: 1270-2445x860-2350mm			

VILAMOURA EXTENSION BANNER



DISPLAY DETAILS

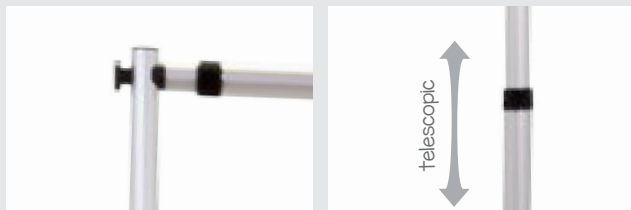

DIMENSIONS

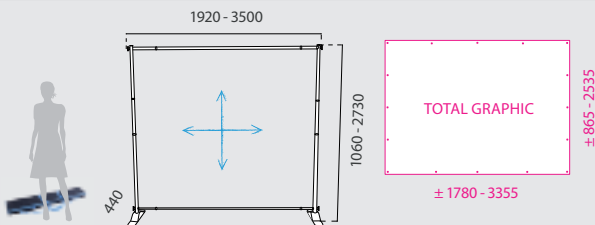

ARTWORK

*mm



INFORMATION

With structure made of aluminium and plastic. Available black or silver finishing. This portable and double-sided banner is ideal for using during a variety of promotional events, such as a trade show, media event, tradeshow exposition or even as solution for a photocall. Each pipe is also designed for an easy and fast telescopic adjustment of the display, allowing the use of graphs of different widths and heights. Vilamoura XXL banner is a big size display fast to assemble and easy to transport, ideal for any promotional event that your business requires. Adjustable height and width structure. Minimum graphic size: \pm Height 1315 x Width 1780mm. Maximum graphic size: \pm Height 2535 x Width 3355mm.

VILAMOURA XXL	QTY	N.W	G.W	C.B.M	SIZE
Packing	1	7kg	8.1kg	0.0266	230x110x1050vmm
13.752	 	Graphic Size: 1780-3355x865-2535mm			

VILAMOURA XXL EXTENSION BANNER

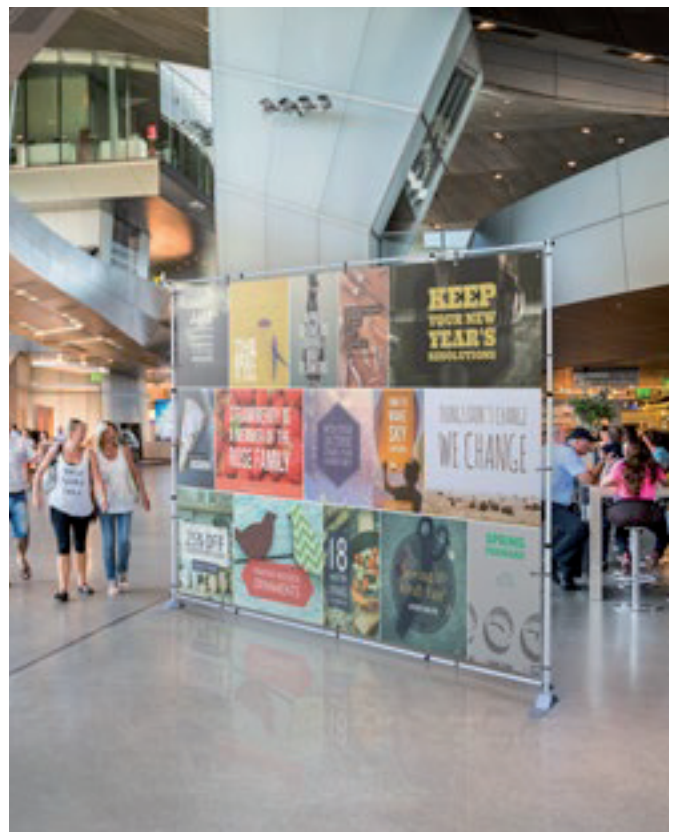
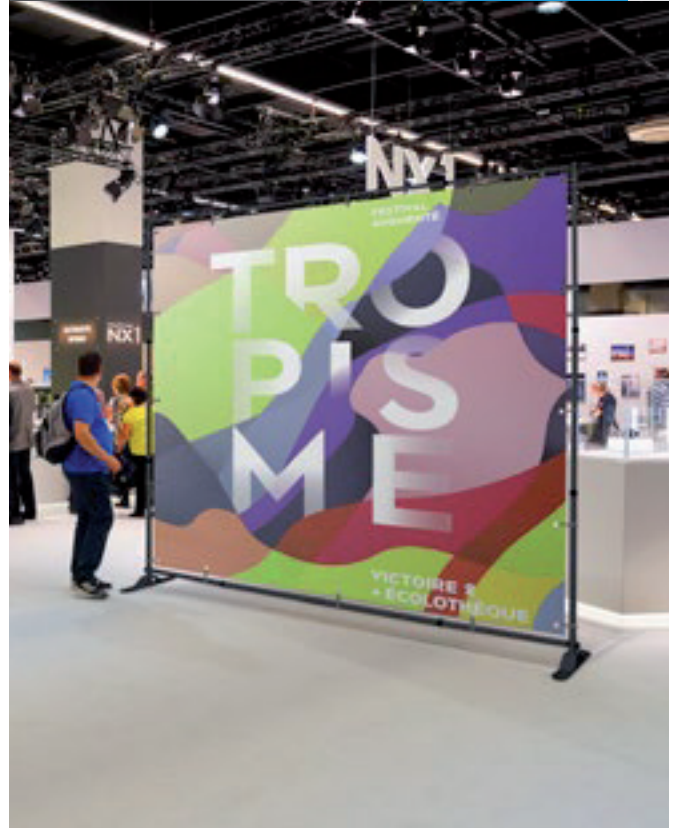

DISPLAY DETAILS



INFORMATION DIMENSIONS ARTWORK *mm

This double sided Poster Display is made of metal, suitable for 2 exhibitions of graphics. It features a telescopic pole (adjustable height of 1000-1600mm).

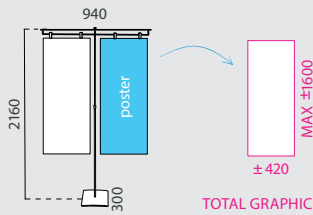

ALGORA	QTY	N.W	G.W	C.B.M	SIZE	
Packing	1	1.2kg	1.6kg	0.02	270x70x1200mm	
10.803	Graphic Size: ±420x1000-1600mm (x2)					

ALGORA



DISPLAY DETAILS



INFORMATION DIMENSIONS ARTWORK *mm

Oropesa Poster Display is made of metal, featuring a special design for an optimum storage. Also, it has a telescopic pole with adjustable height (1100-2100mm). Ideal for promoting your business, such as trade shows and promotional events at stores or business presentations.

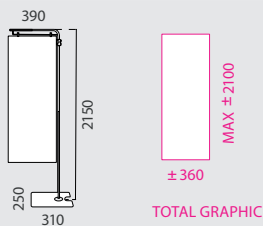

OROPESA	QTY	N.W	G.W	C.B.M	SIZE	
Packing	1	1.96kg	2.53kg	0.05	410x118x1185mm	
10.432	Graphic Size: ±360x1100-2100mm					

OROPESA



DISPLAY DETAILS



INFORMATION

*mm

This portable and detachable display stand features a water refillable base, 6 litres capacity. Made of fiberglass, plastic and lacquered aluminium. Suitable for indoor and outdoor use, features an easy interchange of graphics. Carry bag is included.

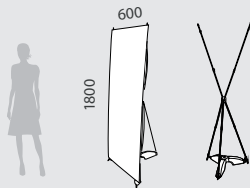

ALMAZAN	QTY	N.W	G.W	C.B.M	SIZE
Pole	1	0.55kg	0.6kg	0.004	80x65x750mm
Base	1	0.95kg	1kg	0.015	250x170x350mm
10.028	Graphic Size: 600x1800mm				



ALMAZAN



DISPLAY DETAILS



INFORMATION

*mm

This portable and detachable display stand features a water refillable base, 6 litres capacity. Made of fiberglass, plastic and lacquered aluminium. Suitable for indoor and outdoor use, features an easy interchange of graphics and adjustable height (telescopic). Carry bag is included.

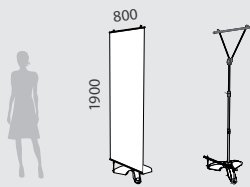

ALMENAR	QTY	N.W	G.W	C.B.M	SIZE
Packing	6	13kg	16.20kg	0.1	400x320x850mm
Uni.	1	1.8kg	2.2kg	0.02	240x100x840mm
10.029	Graphic Size: 800x1900mm				



ALMENAR

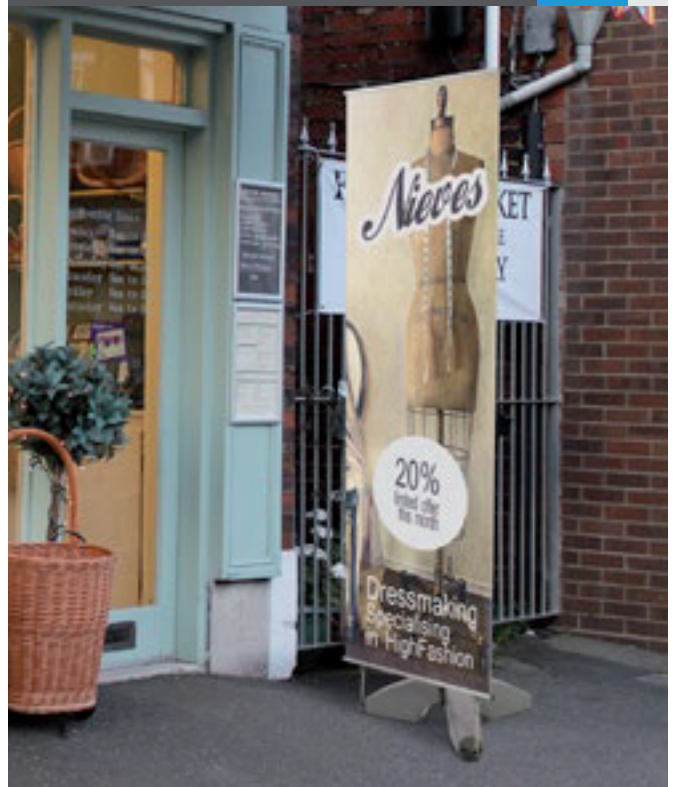

DISPLAY DETAILS

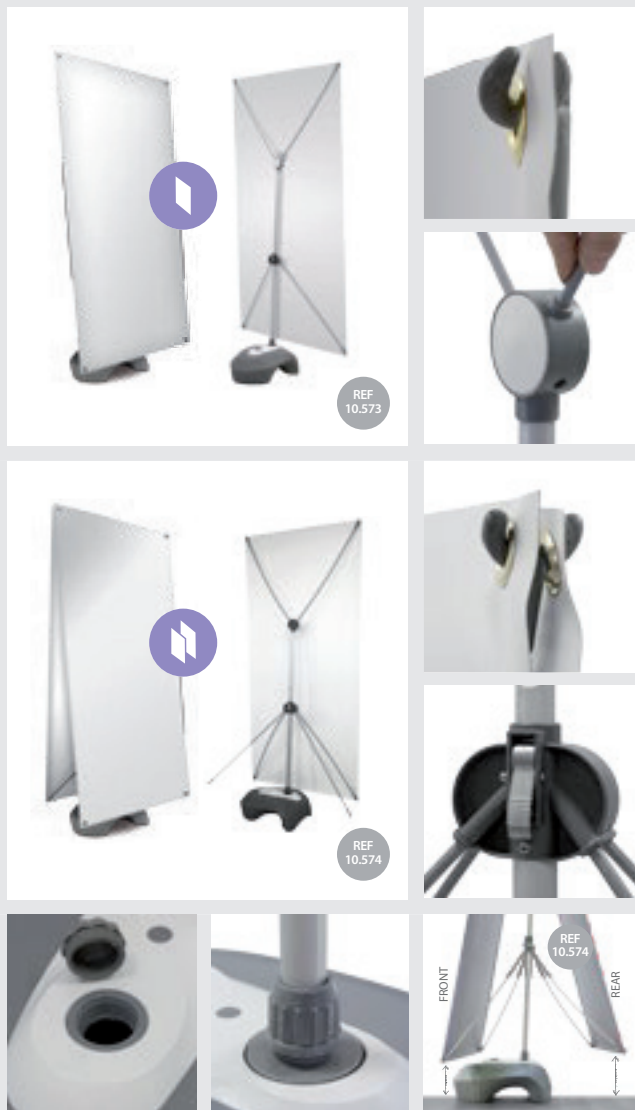

INFORMATION

*mm

This stand display features a 20l water refillable base. The central telescopic hub allows fast height adjustment. Kiel is ideal for indoor or outdoor promotion, and as it can be used to present a double-sided graphic (ideal for areas with 2-ways traffic). Graphics are held with a simple and fast eyelet system. In double-sided Kiel 10.574, after the placement of graphs, the distance to the ground on both sides can differentiate each other: ± 50 mm.

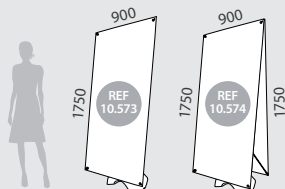

KIEL SINGLE	QTY	N.W	G.W	C.B.M	SIZE
Packing	1	2.8kg	3.25kg	0.09	400x200x1080mm
10.573	Graphic Size: 900x1750mm				
KIEL DOUBLE	QTY	N.W	G.W	C.B.M	SIZE
Packing	1	3kg	3.45kg	0.09	400x200x1080mm
10.574	Graphic Size: 900x1750mm x2				

KIEL



DISPLAY DETAILS



INFORMATION

*mm

Medinaceli is a detachable stand display with a refillable 12L water plastic base which is suitable for indoor and outdoor use. The change of graphic is simple and takes only a few seconds. Includes a nylon Carry Bag for an easy transport and storing.

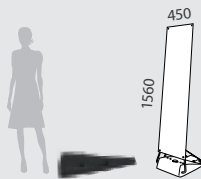

MEDINACELLI	QTY	N.W	G.W	C.B.M	SIZE
Packing	2	7kg	8.6kg	0.11	540x190x1050mm
Uni.	1	2.85kg	3.50kg	0.05	500x100x1030mm
10.026	Graphic Size: 450x1560mm				

MEDINACELI



BASE DETAILS





INFORMATION

*mm

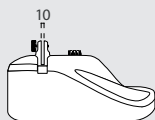
With a durable design and easy portability, this double-sided base with corrugated plastic insert is ideal for placing outdoors, in areas with high foot traffic to draw in new customers. The weighted poster holder can be filled with up to 5l of water or sand. This base is available on Grey or black color.



PANELFIX WING	QTY	N.W	G.W	C.B.M	SIZE
Packing	1	2kg	2.55kg	0.04	440x190x520mm
10.442					
10.443					

PANELFIX WING
OUTDOOR



* Board are available but not included. The price includes only the base.

BASE DETAILS



INSTALL EXPLANATION FOR PANELS UP TO 18mm

1. Place the profile below.
2. Adjust the profile with wheel at the bottom of the PanelFix Wing Aluminium.
3. Max. thickness: 18mm.
4. Place the graphic panel into the slot and adjust it with the wheel until it is properly fixed.

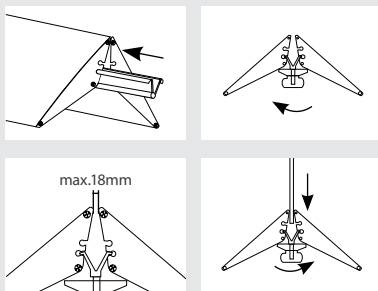

INSTALL EXPLANATION FOR PANELS UP TO 26mm

1. Place the profile above.
2. Adjust the profile with wheel at the bottom of the PanelFix Wing Aluminium.
3. Max. thickness: 26mm.
4. Place the graphic panel into the slot and adjust it with the wheel until it is properly fixed.

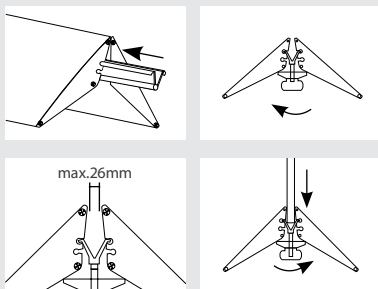

INFORMATION

The PanelFix Wing base made of aluminium is available in three sizes 200, 350 or 550mm and two colors: black or silver. It is designed to hold rigid graphs, allowing the fixing of supports up to 26mm thickness. Also, it allows the printing of any logo on both sides of the base. The double-sided signs help to draw more potential customer coming from both directions into your business.

PF AL 200	QTY	N.W	G.W	C.B.M	SIZE
Packing	1	1.1kg	1.5kg	0.0069	315x93x235mm
10.828		Width: 200mm			
10.829					
PF AL 350	QTY	N.W	G.W	C.B.M	SIZE
Packing	1	2.6kg	3kg	0.0113	315x93x385mm
10.877		Width: 350mm			
10.869					
PF AL 550	QTY	N.W	G.W	C.B.M	SIZE
Packing	1	4.15kg	4.6kg	0.0171	315x93x585mm
10.880		Width: 550mm			
10.870					

PANELFIX WING ALUMINIUM



BASE DETAILS



DIMENSIONS

*mm

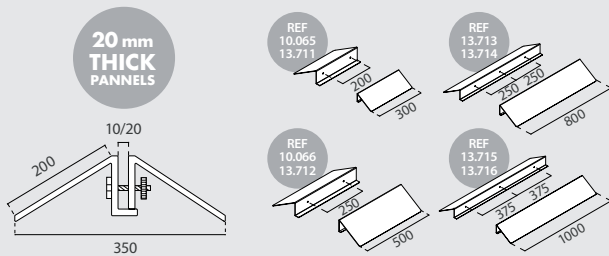

INFORMATION

The Panelfix Wing is a display base made of steel with four available sizes from 300 up to 1000mm and two colors for each size: black or gray. It is designed to hold rigid graphs, allowing the fixing of supports up to 20mm thickness (the max. recommended height is 1500mm). Also, it allows the printing of any logo on both sides of the base. The double-sided signs help to draw more potential customer coming from both directions into your business. The steel base of this sign holder are sturdy enough for multiple uses and years to come, from a crowded trade show floor to a fast paced retail store.

PFIX 300	QTY	N.W	G.W	C.B.M	SIZE
Packing	1	2.75kg	2.95kg	0.0069	210x100x330mm
10.065		Grey	Width: 300mm		
13.711		Black			
PFIX 500	QTY	N.W	G.W	C.B.M	SIZE
Packing	1	4.55kg	4.85kg	0.0111	530x210x100mm
10.066		Grey	Width: 500mm		
13.712		Black			
PFIX 800	QTY	N.W	G.W	C.B.M	SIZE
Packing	1	7.15kg	7.95kg	0.0243	830x255x115mm
13.713		Grey	Width: 800mm		
13.714		Black			
PFIX 1000	QTY	N.W	G.W	C.B.M	SIZE
Packing	1	8.85kg	9.85kg	0.0302	1030x255x115mm
13.715		Grey	Width: 1000mm		
13.716		Black			

PANELFIX WING STEEL

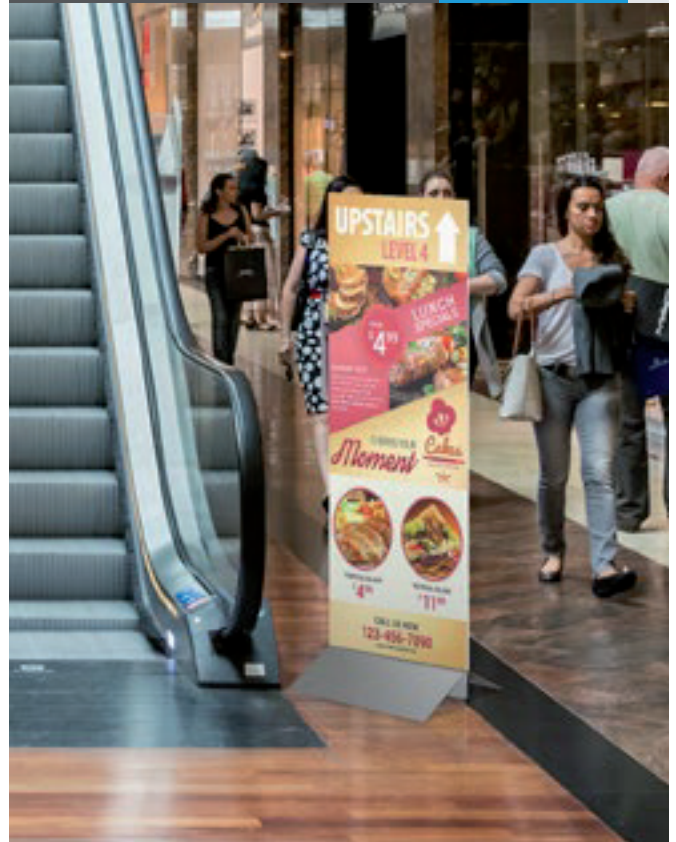

* Boards are available but not included. The price includes only the base.

BASE DETAILS



DIMENSIONS

*mm

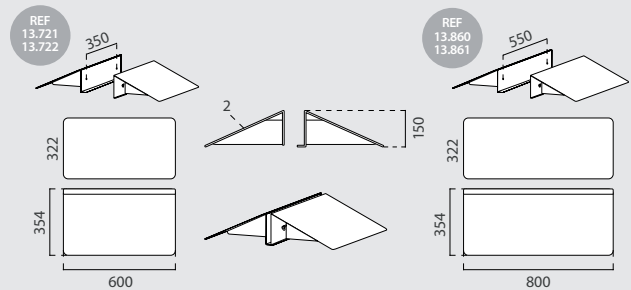

INFORMATION

This base is made of steel sheet of 2mm thickness and it is available in two widths (600 mm and 800mm). It features black laquered (RAL 9005) or grey laquered (RAL 9006). The XL Steel base is ideal to hold rigid materials up to 19mm thickness. The maximum recommended height for the graphic panel is 2000mm. Specially designed for supporting big graphic panels thanks to its weight. This base is a simple clip holder system that grips a board between the two sides to help businesses advertise their products and services. Ideal as a sleek, professional alternative to bulky A-frame Board poster stands.

PFFX XL 600	QTY	N.W	G.W	C.B.M	SIZE
Packing	1	11.85kg	12.55kg	0.0486	400x190x640mm
13.721		Grey		600x663x150mm	
13.722		Black			
PFFX XL 800	QTY	N.W	G.W	C.B.M	SIZE
Packing	1	14.25kg	15kg	0.064	400x190x840mm
13.860		Grey		800x663x150mm	
13.861		Black			

new

PANELFIX WING STEEL XL



* Boards are available but not included. The price includes only the base.

BASE DETAILS



DIMENSIONS

*mm

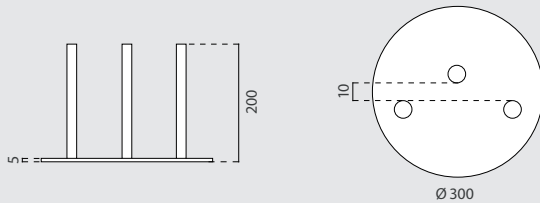

INFORMATION

The Montijo Poster Display is a Ø300mm base made of 5mm thickness steel sheet. It is 200mm height and is available in black or white colored. It is ideal for holding rigid materials up to 10mm thickness and includes anti-scratch felt pads at bottom. The double-sided signs help to draw more potential customer coming from both directions into your business. The steel base of this sign holder are sturdy enough for multiple uses and years to come, from a crowded trade show floor to a fast paced retail store.

MONTIJO	QTY	N.W	G.W	C.B.M	SIZE
Packing	2	7.2kg	7.75kg	0.024	310x250x310mm
10.898	<input checked="" type="checkbox"/>	Size: Ø300x200mm x2 			
10.838	<input type="checkbox"/>				

MONTIJO



* Boards are available but not included. The price includes only the base.

BASE DETAILS



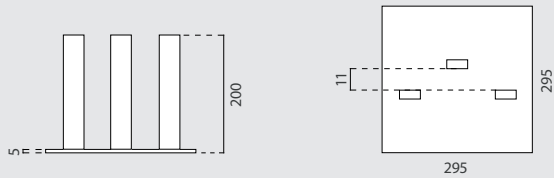

DIMENSIONS

*mm



INFORMATION

This base is made of 5mm thickness steel sheet. It features anti-scratch felt pads at bottom. Available in black or white colored. The steel base of this sign holder are sturdy enough for multiple uses and years to come, from a crowded trade show floor to a fast paced retail store. The Balboa base is ideal to hold rigid materials up to 11mm thickness.

BALBOA	QTY	N.W	G.W	C.B.M	SIZE
Packing	2	9.00kg	9.60kg	0.024	310x250x310mm
10.894		295x200x295mm		x2	
10.895					

BALBOA

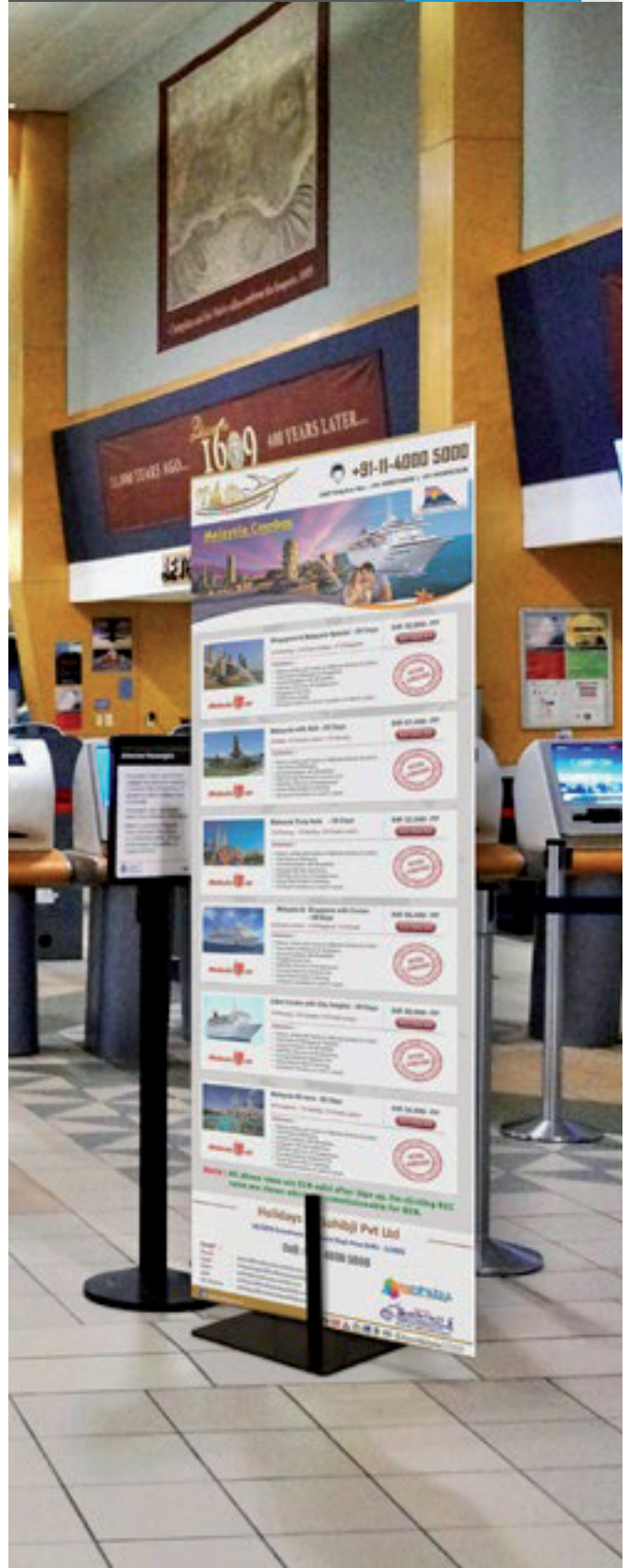

* Boards are available but not included. The price includes only the base.

BASE DETAILS

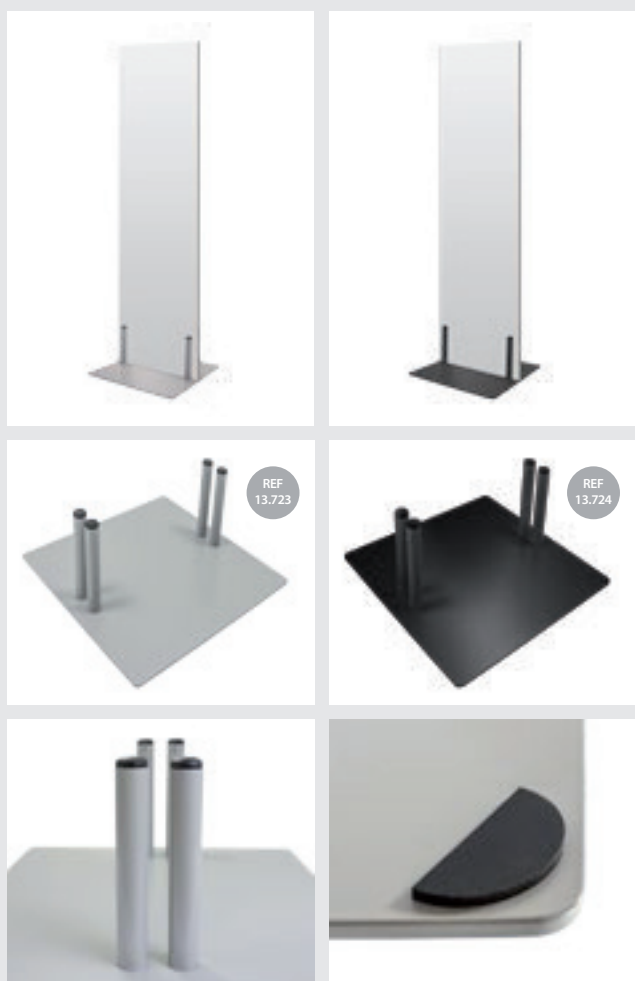

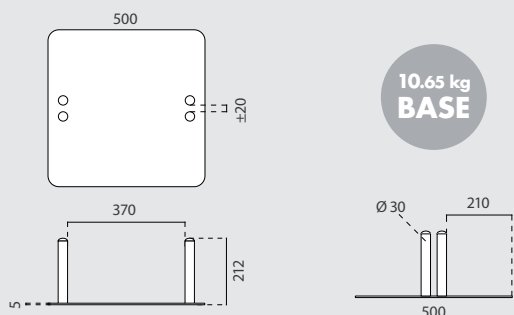

DIMENSIONS

*mm



INFORMATION

The Balboa XL is made of steel sheet of 5mm thickness. It features black laquered (RAL 9005) or grey laquered (RAL 9006) finish. This XL Steel base is ideal to hold rigid materials up to 19mm thickness. Specially designed for supporting big graphic panels (2000mm max. height recommended) thanks to its 10.65kg.

BALBOA XL	QTY	N.W	G.W	C.B.M	SIZE
Packing	1	11.30kg	12.10kg	0.0772	545x545x260mm
13.723		Grey	500x212x500mm		
13.724		Black			

BALBOA XL



* Boards are available but not included. The price includes only the base.



click



Click Boards

SIDEWALK DETAILS



SIDEWALK DETAILS

GRAPHIC BY CLICK FRAME



DIMENSIONS

* W: Width H: Height D: Depth * mm

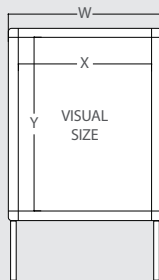
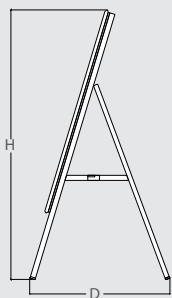

click

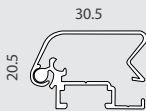

INFORMATION

This frame board is made of aluminum so it is lightweight and resistant to rusting. It has a 30.5mm width profile with click system, so the graphic change is quick and simple. With its single-sided folding frame, Niza A-Board is ideal for advertising outside your store, like restaurants, street stalls or supermarkets. It includes a weather resistant antireflection sheet so is also non-glare which allows it to be read under bright lights.

NIZA



NIZA	QTY	N.W	G.W	C.B.M	Size (WxHxD)
Packing	1	5kg	7kg	0.075	580x1080x120
		Visual (X-Y)	External (WxHxD)		
Product	485x685		540x1060x440		
10.808		Graphic Size: 500x700mm			

SIDEWALK DETAILS



DIMENSIONS

* W: Width H: Height D: Depth * mm

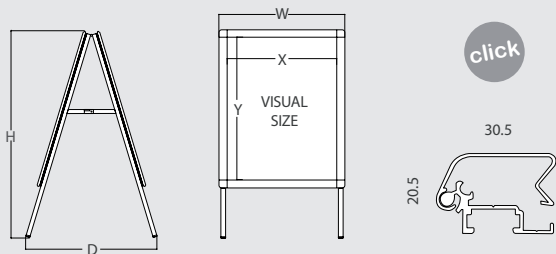

INFORMATION

Bayonne Sidewalk is made of aluminum so it is lightweight and resistant to rusting. It has feet protection to avoid slipping and a 30.5mm width profile with click system, so the graphic change is fast and simple. Also, it includes a weather resistant antireflection sheet so is also non-glare which allows it to be read under bright lights. With its 2-sided folding frame, The Bayonne Sidewalk is ideal for advertising sales inside or outside your store.

H700	QTY	N.W	G.W	C.B.M	Size (WxHxD)
Packing	1	4.85kg	6.5kg	0.068	509x1120x120
		Visual (X-Y)	External (WxHxD)		
Product	485x685	545x1030x532			

10.804 Graphic Size: 500x700mm

H1000	QTY	N.W	G.W	C.B.M	Size (WxHxD)
Packing	1	7.64kg	9.6kg	0.127	795x1400x115
		Visual (X-Y)	External (WxHxD)		
Product	687x988	745x1330x605			

10.805 Graphic Size: 700x1000mm

A1	QTY	N.W	G.W	C.B.M	Size (WxHxD)
Packing	1	6.7kg	8.5kg	0.101	695x1220x120
		Visual (X-Y)	External (WxHxD)		
Product	580x830	640x1170x540			

13.145 Graphic Size: A1

A0	QTY	N.W	G.W	C.B.M	Size (WxHxD)
Packing	1	10.2kg	12.45kg	0.175	930x1575x120
		Visual (X-Y)	External (WxHxD)		
Product	825x1170	885x1520x585			

13.146 Graphic Size: A0

BAYONNE



ANTIREFLECTION SHEET

- EN Antireflection sheet for snapframe.
- FR Antireflet pour cadres ou chevalets.
- PT Pelicula antireflexo para marcos e caveletes.
- ES Antireflex para marcos y caballetes.



SHEET

SIZE

10.952	500x700mm
10.953	700x1000mm
10.992	A1 598x838mm
10.993	A0 838x1188mm

SIDEWALK DETAILS

GRAPHIC BY CLICK FRAME



INFORMATION

* W: Width H: Height D: Depth * mm

Grenoble is a small dimensions A-frame aluminium board. It is lightweight and resistant to rusting. It has a 32mm click system profile. Grenoble is ideal for advertising events, menus or last offers outside your shop. Includes a weather resistant antireflection sheet.

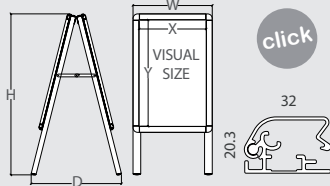

GRENOBLE	QTY	N.W	G.W	C.B.M	Size (WxHxD)
Packing	1	4.3kg	5kg	0.0374	425x880x100
		Visual (X-Y)	External (WxHxD)		
Product	341x541	404x815x456			
10.942	Graphic Size: 340x540mm				

GRENOBLE



SIDEWALK DETAILS

GRAPHIC BY CLICK FRAME



INFORMATION

* W: Width H: Height D: Depth * mm

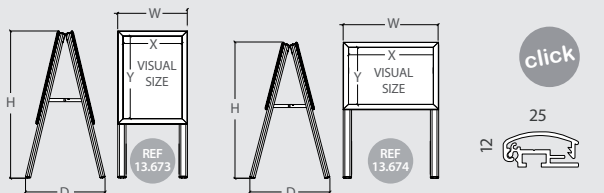

Poisat is a small dimensions aluminium A-frame Board. It is lightweight and resistant to rusting. It has a 25mm width click system profillet. Ideal for advertising your upcoming events, shows, menu or last offers at your show window. It includes a weather resistant antireflection sheet.

PORTRAIT	QTY	N.W	G.W	C.B.M	Size (WxHxD)
Packing	1	2.77kg	3.298kg	0.0244	340x715x85
		Visual (X-Y)	External (WxHxD)		
Product	279x402	332x699x379			
13.673	Graphic Size: A3 Portrait				

LANDSCAPE	QTY	N.W	G.W	C.B.M	Size (WxHxD)
Packing	1	2.63kg	3.257kg	0.0308	460x670x85
		Visual (X-Y)	External (WxHxD)		
Product	279x402	455x648x381			
13.674	Graphic Size: A3 Landscape				

POISAT



SIDEWALK DETAILS

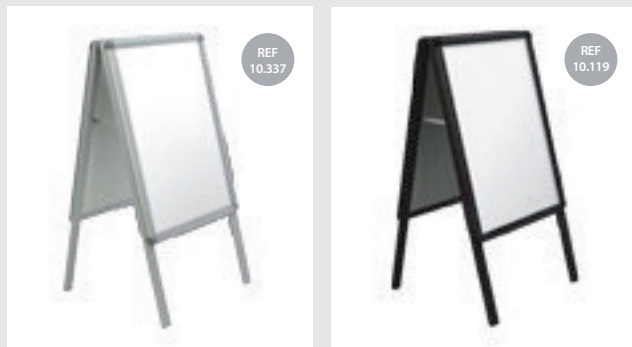

INFORMATION

* W: Width H: Height D: Depth * mm

Merida has a 32mm width aluminium profile with click system, so it is lightweight and resistant to rusting. Merida has feet protections to avoid slipping and a weather resistant antireflection sheet included. It is ideal for being used inside or outside of your business.

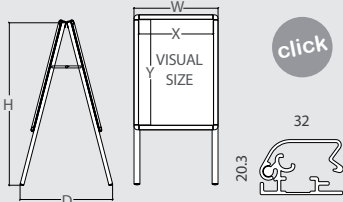

[click](#)

RAL COLORS AVAILABLE



MERIDA A1	QTY	N.W	G.W	C.B.M	Size (WxHxD)
Packing	1	7.92kg	9.69kg	0.098	660x1420x105
		Visual (X-Y)	External (WxHxD)		
Product		575x822	638x1400x698		GRAPHIC SIZE
10.337					A1
10.119					

MERIDA H700	QTY	N.W	G.W	C.B.M	Size (WxHxD)
Packing	1	5.64kg	6.7kg	0.072	575x1100x115
		Visual (X-Y)	External (WxHxD)		
Product		481x681	544x1050x598		GRAPHIC SIZE
10.338					500x700mm
10.122					

MERIDA H1000	QTY	N.W	G.W	C.B.M	Size (WxHxD)
Packing	1	8.94kg	10.67kg	0.127	765x1445x115
		Visual (X-Y)	External (WxHxD)		
Product		681x981	744x1400x799		GRAPHIC SIZE
10.339					700x1000mm
10.124					

MERIDA



SIDEWALK DETAILS

* mm

GRAPHIC BY CLICK FRAME

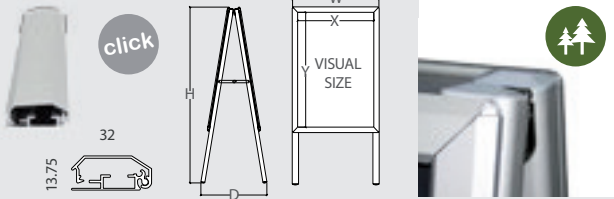

INFORMATION

The Dijon Sidewalk is designed for outdoor use so it's perfect for advertising outside or inside your store. It has a 32mm width aluminium profile with click system, so the graphic change is quick and simple. Thanks to its double-sided frame is ideal for displaying offers, menus, information maps, etc. It includes a weather resistant antireflection sheet.

DIJON H700	QTY	N.W	G.W	C.B.M	Size (WxHxD)
Packing	1	5kg	6.5kg	0.0877	580x1120x135
		Visual (X-Y)	External (WxHxD)		
Product	478x678		542x1038x414		
10.558	Graphic Size: 500x700mm				
DIJON A1	QTY	N.W	G.W	C.B.M	Size (WxHxD)
Packing	1	6.4kg	8.5kg	0.0984	660x1420x105
		Visual (X-Y)	External (WxHxD)		
Product	572x819		636x1382x536		
10.557	Graphic Size: A1				
DIJON H1000	QTY	N.W	G.W	C.B.M	Size (WxHxD)
Packing	1	7.9kg	9.65kg	0.1562	790x1465x135
		Visual (X-Y)	External (WxHxD)		
Product	678x978		742x1382x536		
10.559	Graphic Size: 700x1000mm				

DIJON

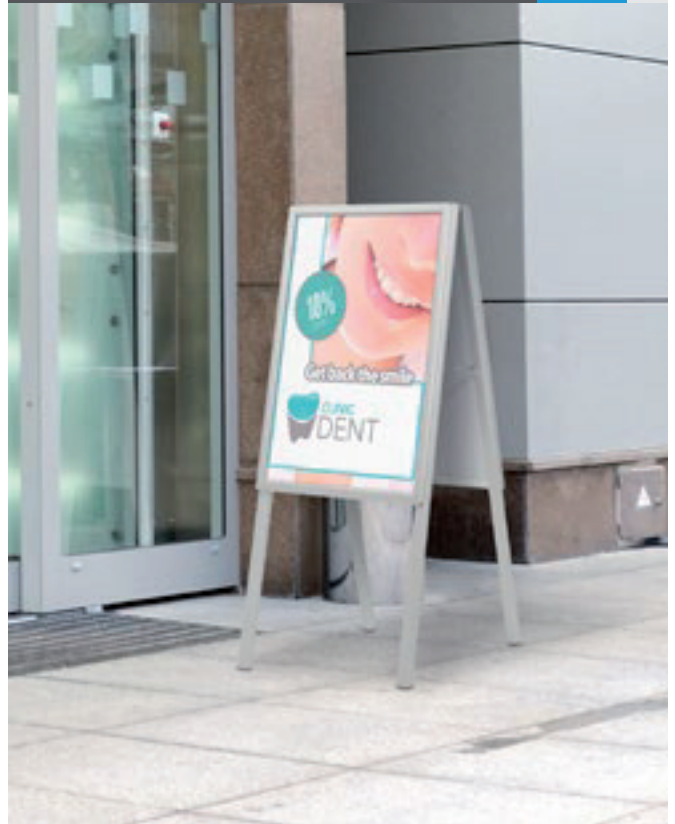

SIDEWALK DETAILS

GRAPHIC BY CLICK FRAME



INFORMATION

* mm

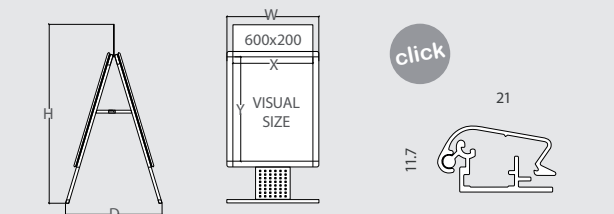

This double-sidewalk is made of aluminum so it is lightweight and resistant to rusting. It has a 21mm width click system profile. It features a headboard support for displaying a graphic. Ideal for outside or inside your store, restaurant, street stall or supermarket. It includes a weather resistant antireflection sheet.

BELMEZ	QTY	N.W	G.W	C.B.M	Size (WxHxD)
Packing	1	13.9kg	15.7kg	0.1085	690x1210x130
		Visual (X-Y)	External (WxHxD)		
Product	581x828		647x1160x625		
10.235	Graphic Size: A1				

BELMEZ



SIDEWALK DETAILS



DIMENSIONS

* W: Width H: Height D: Depth * mm

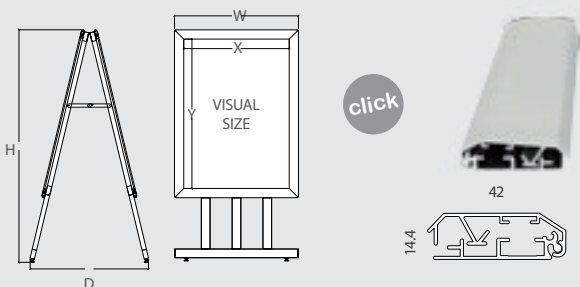

INFORMATION

Montanchez Sidewalk features and structure made of aluminum over a steel structure so this way, its extra weight gives a great stability and it's very resistant to rusting. It has non-slip leveling feet and also a 42mm width profile with click system, so the graphic change is quick and simple. With its double-sided folding frame, Montanchez is designed especially for outdoor use so it's perfect for advertising sales and promotions outside your store. It includes a weather resistant antireflection sheet so is also non-glare which allows it to be read under the bright lights.

H700	QTY	N.W	G.W	C.B.M	Size (WxHxD)
Packing	1	11.95kg	13.1kg	0.070	560x1090x115
		Visual (X-Y)	External (WxHxD)		
Product		480x660	564x1052x524		

10.127 Graphic Size: 500x700mm

H1000	QTY	N.W	G.W	C.B.M	Size (WxHxD)
Packing	1	17.25kg	19.3kg	0.121	880x1375x100
		Visual (X-Y)	External (WxHxD)		
Product		680x960	764x1402x525		

10.128 Graphic Size: 700x1000mm

H1400	QTY	N.W	G.W	C.B.M	Size (WxHxD)
Packing	1	25.5kg	28.5kg	0.1886	1100x1805x98
		Visual (X-Y)	External (WxHxD)		
Product		980x1360	1064x1802x566		

10.129 Graphic Size: 1000x1400mm

MONTANCHEZ



SIDEWALK BOARDS



Click Boards

SIDEWALK DETAILS



SIDEWALK DETAILS

GRAPHIC BY CLICK FRAME



DIMENSIONS

* W: Width H: Height D: Depth * mm

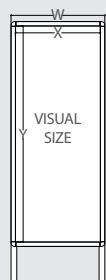
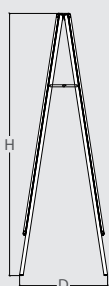

INFORMATION

The Poznan A-board frame is made of aluminum so it is lightweight and resistant to rusting and it is available on black or silver color. It has a 32mm width profile with click system, so the graphic change is quick and simple. Thanks its double-sided frame and its 1800mm height this A-Board is ideal for advertising large offers, menus, information maps, etc, outside or inside your business. It includes a weather resistant antireflection sheet so is also non-glare which allows it to be read under bright lights.

POZNAN	QTY	N.W	G.W	C.B.M	Size (WxHxD)
Packing	1	12.9kg	14.8kg	0.177	705x1860x135
	Visual (X-Y)		External (WxHxD)		
Product	581x1481		644x1800x600		
10.343			Graphic Size: 600x1500mm		

POZNAN





SIDEWALK DETAILS



DIMENSIONS

* W: Width H: Height D: Depth * mm

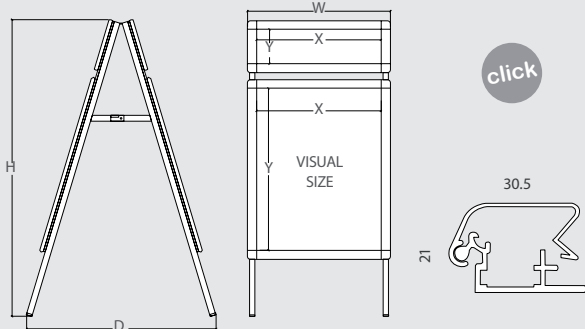

INFORMATION

Toulouse double-Sidewalk is made of aluminum so it is lightweight and resistant. It has a 30.5mm width profile with click system, so the graphic change is quick and simple. Also it includes a resistant antireflection sheet so is also non-glare which allows it to be read under bright lights. Features a headboard support for displaying company logos or graphs. Ideal for displaying sales or promotions at restaurants, stores, shops or supermarkets.

TOULOUSE	QTY	N.W	G.W	C.B.M	Size (WxHxD)
Packing	1	9kg	11kg	0.1010	610x120x1380
	Board Visual (X-Y)	Upper Visual (X-Y)	External (WxHxD)		
Product	485x685	485x185	545x1210x630		
10.806	Board Graphic Size: 500x700mm		Upper Graphic Size: 500x200mm		

TOULOUSE



DISPLAY DETAILS



CLICK FRAME PROFILE DETAILS



DIMENSIONS

* W: Width H: Height D: Depth * mm

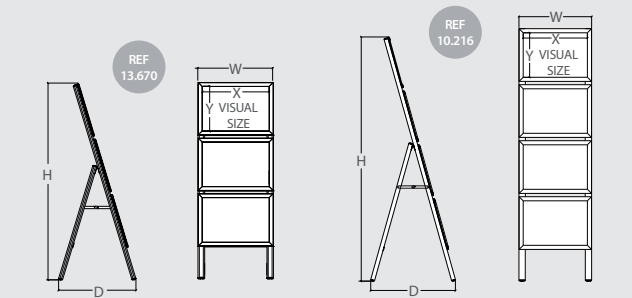

INFORMATION

This anodized aluminium A-Board is very lightweight, foldable for an easy storage and very resistant to rusting. It features a 25mm width profile with click system, so the graphic change is quick and simple. Also it includes a weather resistant antireflection sheet. The Mota A-Board range features 2 configurations of A3 frames. They are ideal for advertising sales or special promotions inside or outside your business. It's perfect for restaurants, stalls, stores or for any marketplace.

MOTA A3x3	QTY	N.W	G.W	C.B.M	Size (WxHxD)
Packing	1	4.2kg	5.218kg	0.0566	475x1255x95
		Visual (X-Y)	External (WxHxD)		
Product	402x279		455x1182x466		
13.670	Graphic Size: A3 x3				
MOTA A3x4	QTY	N.W	G.W	C.B.M	Size (WxHxD)
Packing	1	5.7kg	6.7kg	0.0722	475x1600x95
		Visual (X-Y)	External (WxHxD)		
Product	402x279		450x1530x490		
10.216	Graphic Size: A3 x4				



MOTA SINGLE-SIDED

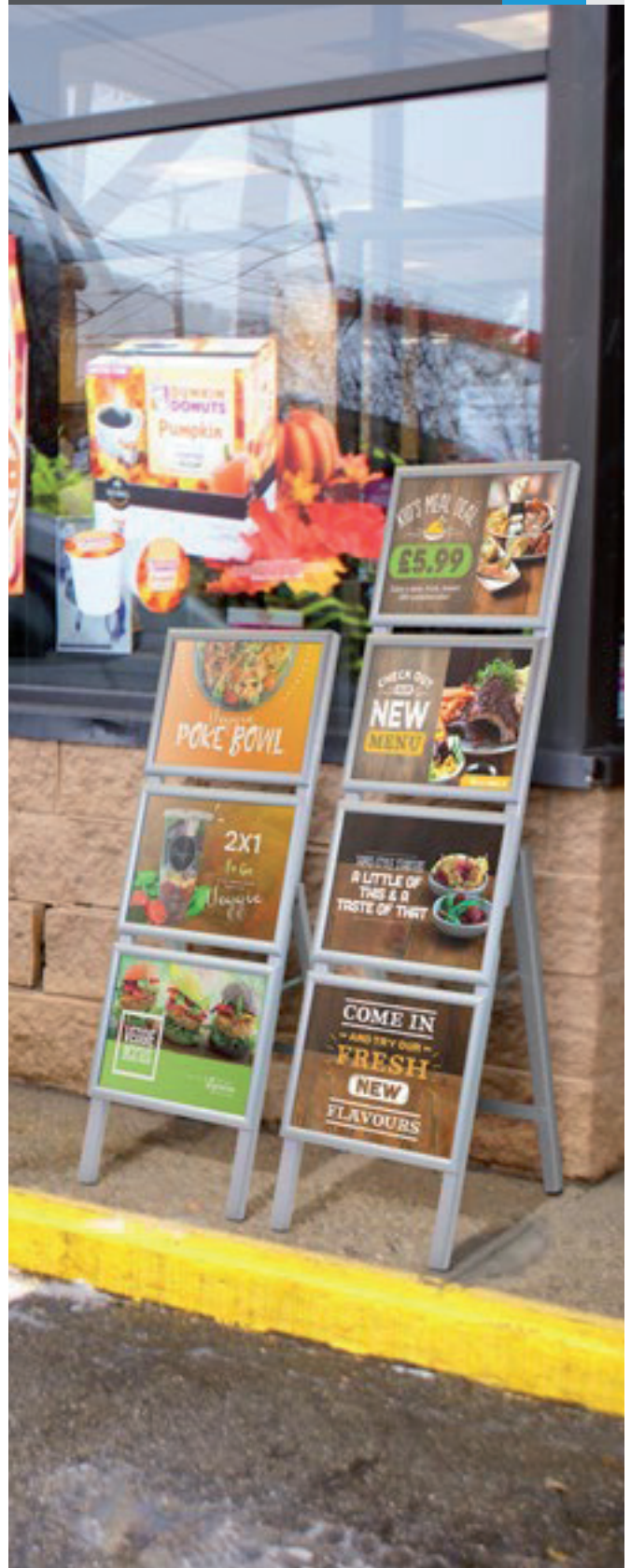

NEW



SIDEWALK DETAILS

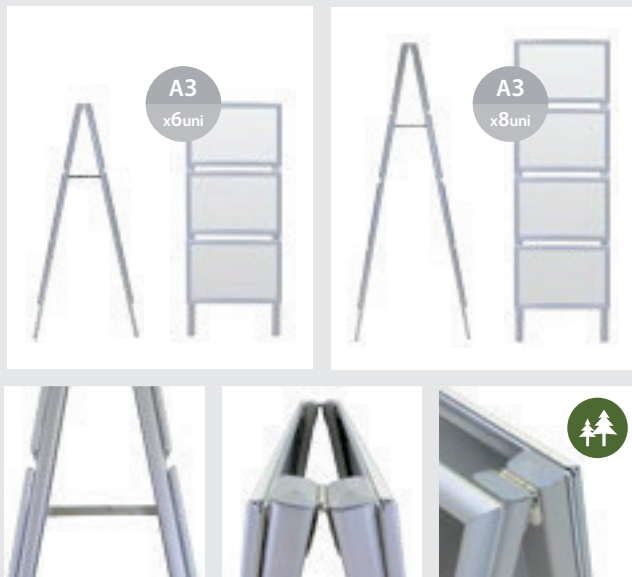

CLICK FRAME PROFILE DETAILS

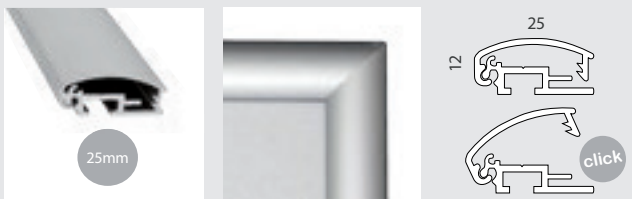

DIMENSIONS

* W: Width H: Height D: Depth * mm

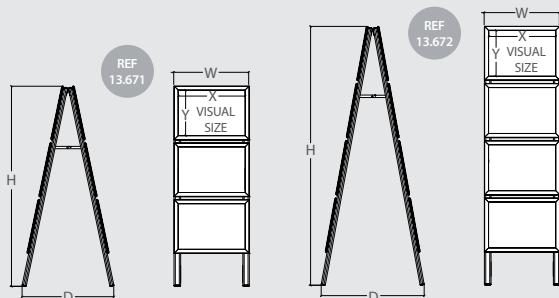

INFORMATION

This anodized aluminium A-Board is very lightweight, foldable for an easy storage and very resistant to rusting. It features a 25mm width profile with click system, so the graphic change is quick and very simple. Also it includes a weather resistant antireflection sheet so is also non-glare which allows it to be read under bright lights. The Mota A-Board range features 2 configurations of A3 frames. They are ideal for advertising sales or special promotions inside or outside your business. It's perfect for restaurants, stalls, stores or for any marketplace.

MOTA A3 3+3	QTY	N.W	G.W	C.B.M	Size (WxHxD)
Packing	1	6.4kg	7.418kg	0.0566	475x1255x95
		Visual (X-Y)		External (WxHxD)	
Product		402x279	455x1207x553		
13.671		Graphic Size: A3 3+3			
MOTA A3 4+4	QTY	N.W	G.W	C.B.M	Size (WxHxD)
Packing	1	8.3kg	9.559kg	0.0722	475x1600x95
		Visual (X-Y)		External (WxHxD)	
Product		402x279	455x1557x619		
13.672		Graphic Size: A3 4+4			

MOTA
DOUBLE-SIDED



SIDEWALK DETAILS



with
rechargeable
battery



DIMENSIONS

* W: Width H: Height D: Depth * mm

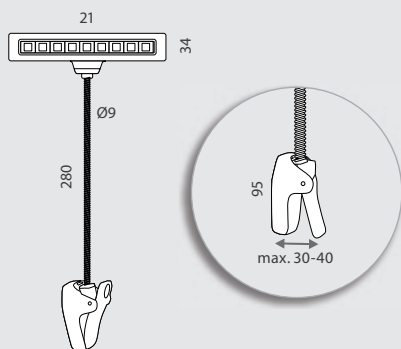

INFORMATION

The Portable and rechargeable 1.8W LED Lamp is a very useful accessory for any display, has an autonomy of more than 6 hours and three levels of brightness (featuring a charging indicator display). With a stunning black finish, this portable LED Lamp will add a touch of distinction and functionality to your display. Thanks to its low consumption and its high strength clamp (3-4cm maximum grip) it can be coupled to a wide range of display products, among them Frame Boards, Blackboards, Photocalls, Lecterns or Counters.

SPOTLIGHT	QTY	N.W	G.W	C.B.M	Size (WxHxD)
Packing	1	0.30kg	0.40kg	0.00174	110x227x70
13.642					

PORTABLE LED LAMP



14.111
A-BOARD SPECIAL TOP
Seen in BLACKBOARDS



13.641
WOODEN FAST LECTERN
LECTERNS
Seen in FRAMES & INFORMATIVE HOLDERS



10.996
STEEL DISPLAY
POSTER DISPLAY
Seen in STAND DISPLAYS

SIDEWALK DETAILS



DIMENSIONS

* W: Width H: Height D: Depth * mm

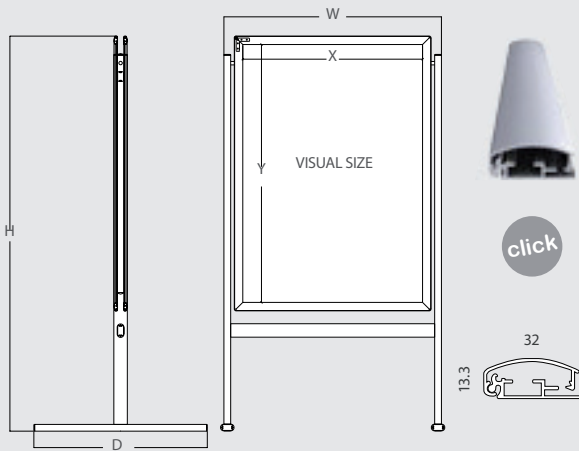

INFORMATION

The Ibahernando Sidewalk is made of aluminum so it is lightweight and resistant to rusting and wind thanks its strong 847mm length feet. It features a 32mm width profile with click system, so the graphic change is fast and simple y a few seconds. Also it features a revolving board design and it includes a resistant antireflection sheet so is also non-glare which allows it to be read under bright lights. Ibahernando Sidewalk is ideal for displaying sales or promotions at restaurants, stores, shops or at supermarkets.

IBAHERNANDO	QTY	N.W	G.W	C.B.M	Size (WxHxD)
Packing	1	9.6kg	11.8kg	0.141	875x1535x105
	Visual (X-Y)		External (WxHxD)		
Product	686x986		821x1506x847		
10.165	Graphic Size: 700x1000mm				

IBAHERNANDO

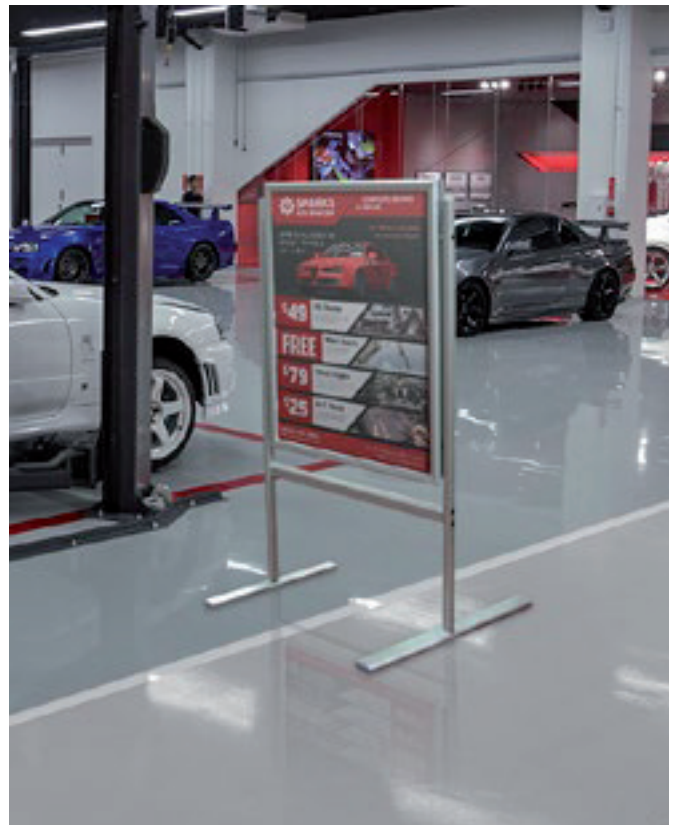
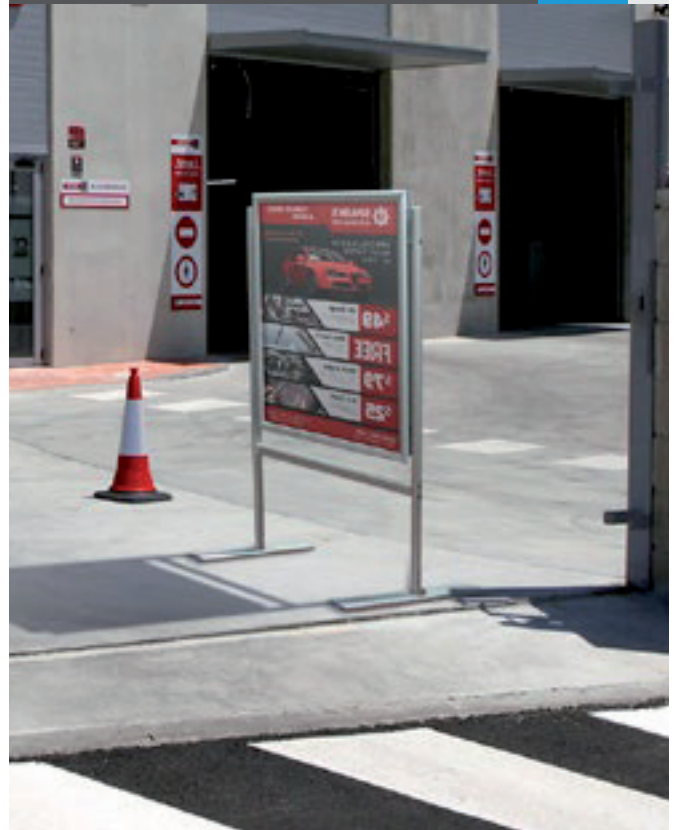



SIDEWALK DETAILS



DIMENSIONS

* W: Width H: Height D: Depth * mm

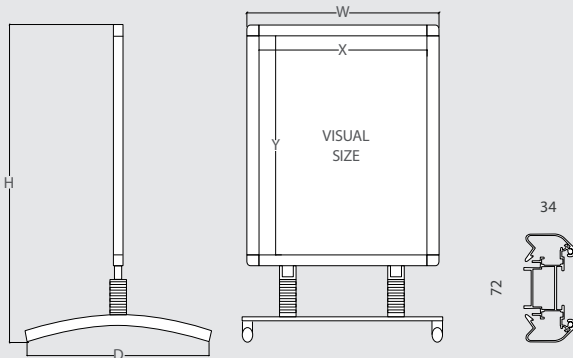

INFORMATION

Boal Sidewalk is made of aluminum and has a strong base and sturdy springboard design which allows flexion in windy conditions. It has a 34mm width profile with click system, so the graphic change is quick and simple. It includes a resistant antireflection sheet so is also non-glare which allows it to be read under bright lights. Ideal for displaying outside your event, restaurant, street stall or supermarket for advertising offers or temporary exhibitions.

BOAL



BOAL	QTY	N.W	G.W	C.B.M	Size (WxHxD)	
Packing	1	7.8kg	9.4kg	0.066	750x1100x80	x2
	1	4.55kg	4.85kg	0.009	140x670x100	
		Visual (X-Y)	External (WxHxD)			
Product		570x815	640x1130x560			
10.166		Graphic Size: 605x860mm				



SIDEWALK DETAILS



DIMENSIONS

* W: Width H: Height D: Depth * mm

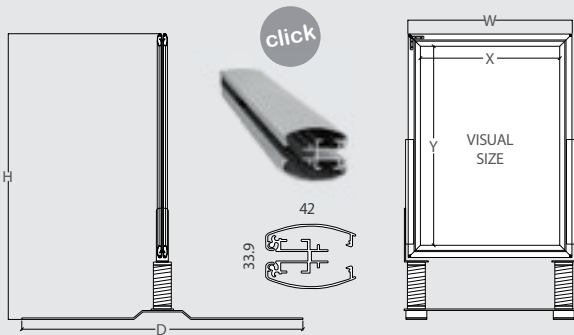

INFORMATION

Hervas Sidewalk is made of aluminum and has a strong base with a wide footprint and sturdy springboard design which allows the flexion in windy conditions. It has a 42mm width profile with click system, so the graphic change is quick and simple. It includes a resistant antireflection sheet. Ideal for being used inside or outside your gas station, restaurant, street stall or supermarket for advertising last promotions.

HERVAS H700	QTY	N.W	G.W	C.B.M	Size (WxHxD)
Packing	1	4.2kg	5.05kg	0.0373	965x595x65
	1	9.35kg	9.5kg	0.0043	1010x77x55
		Visual (X-Y)	External (WxHxD)		
Product	466x666		575x956x940		



10.161 Graphic Size: 500x700mm

HERVAS H1000	QTY	N.W	G.W	C.B.M	Size (WxHxD)
Packing	1	6.75kg	8.45kg	0.0574	785x1125x65
	1	9.35kg	9.5kg	0.0043	1010x77x55
		Visual (X-Y)	External (WxHxD)		
Product	666x966		750x1256x940		



10.162 Graphic Size: 700x1000mm

HERVAS



SIDEWALK BOARDS



Click Refillable Base

SIDEWALK DETAILS



DIMENSIONS

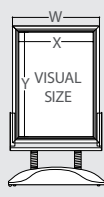
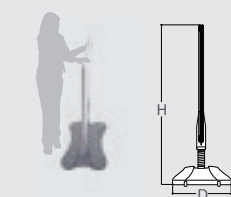

PROFILE

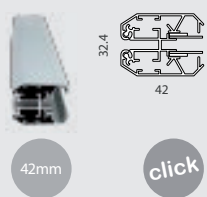

INFORMATION

This waterproof Click Board is designed especially for outdoor use. The heavy-duty, molded plastic base features a screw-in cap and can be filled with 24l of water for 10.341 and 10.115 models and 52l for 10.116 and 10.342. Also it has a 42mm width waterproof profile with click system, so the graphic change is quick and simple (weather resistant antireflection sheet included). Built-in wheels also make this board easy to move as needed. To further enhance its stability Arcachon features rugged springs to reduce the impact of wind. Ideal for displaying outside the restaurants, street stall, events, supermarkets or fuel stations.

ARCACHON H500	QTY	N.W	G.W	C. B.M	Size (WxHxD)	
Packing	1 Frame	6.75kg	8.1kg	0.0475	660x900x80	
	1 Base	3.7kg	4.4kg	0.068	800x170x500	
		Visual (X-Y)		External (WxHxD)		
Product		478x678	542x1038x510			

10.115 **Graphic Size: 500x700mm**

ARCACHON A1	QTY	N.W	G.W	C. B.M	Size (WxHxD)	
Packing	1 Frame	8.1kg	9.2kg	0.0616	740x1040x90	
	1 Base	3.7kg	4.4kg	0.068	800x170x500	
		Visual (X-Y)		External (WxHxD)		
Product		572x819	636x1382x510			

10.341 **Graphic Size: A1**

ARCACHON H700	QTY	N.W	G.W	C. B.M	Size (WxHxD)	
Packing	1 Frame	9.1kg	10.5kg	0.0745	810x1150x80	
	1 Base	5.75kg	6.5kg	0.1085	970x610x180	
		Visual (X-Y)		External (WxHxD)		
Product		678x978	742x1382x510			

10.116 **Graphic Size: 700x1000mm**

ARCACHON A0	QTY	N.W	G.W	C. B.M	Size (WxHxD)	
Packing	1 Frame	10.25kg	11.60kg	0.1051	980x1340x80	
	1 Base	5.75kg	6.5kg	0.1085	970x610x180	
		Visual (X-Y)		External (WxHxD)		
Product		833x1182	920x1510x510			

10.342 **Graphic Size: A0**

ARCACHON



ANTIREFLECTION SHEET



- EN Antireflection protector sheet for snapframes.
- FR Antireflet pour cadres ou chevalets.
- PT Película antirreflexo para marcos e cavaletes.
- ES Protector antirreflex para marcos y caballetes.

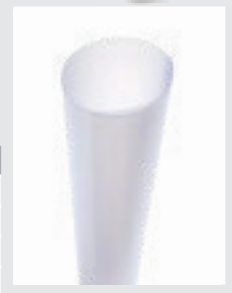

SHEET	SIZE
13.836	534x734mm
13.837	735x1034mm
13.838	628x875mm
13.839	875x1223mm

SIDEWALK DETAILS

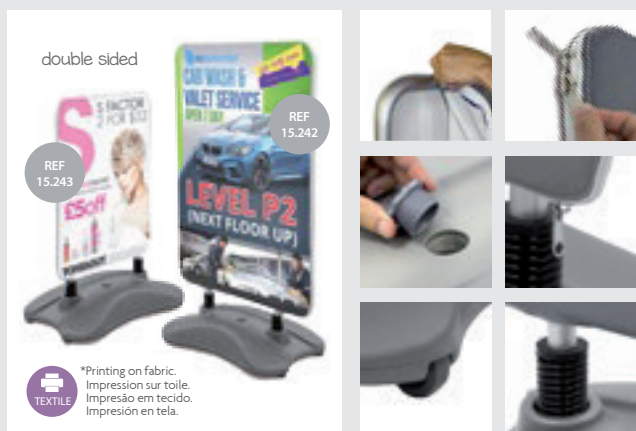

EXTERNAL SIZES & DOWNLOADABLES ARTWORKS (QR CODE) *mm

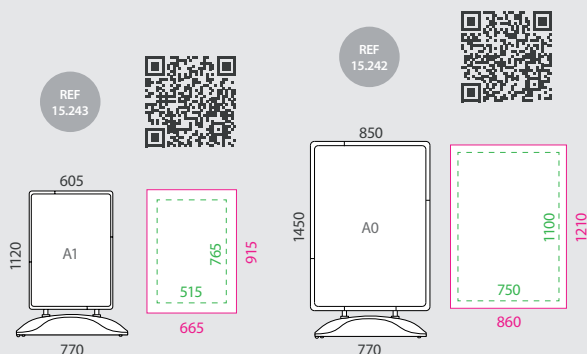

SAFE ZONE
TOTAL GRAPHIC



SAFE ZONE
TOTAL GRAPHIC

INFORMATION

The Mikonos Sidewalk features a lightweight aluminum structure with a refillable plastic base that assembles in seconds (It is 3.95kg weight and it can be filled with 17l of water or sand). Also, the Textile Boards are also simple to setup. All the aluminium poles fit together and snap into base. Simply stretch the wrap over the completed base and it's ready to use. The aluminium structure is affixed to the base with 2 large springs, so it stays stable in windy conditions. Built-in wheels also make this board easy to move as needed. A Nylon Carrying bag is included for an easy storage and transportation. Ideal for denoting your business with the innovative design and versatility of textil printing. The Sidewalk is ideal for being used inside or outside of your restaurant, workshop, street stall, supermarket or heavily-trafficked areas such as tradeshows, events or conventions.

MIKONOS A1	QTY	N.W	G.W	C.B.M	Size (WxHxD)	
Packing	1	7.5kg	9.5kg	0.11	520x940x230	
15.243	Graphic Size:665x915mm					

MIKONOS A0	QTY	N.W	G.W	C.B.M	Size (WxHxD)	
Packing	1	8kg	10kg	0.11	520x940x230	
15.242	Graphic Size:860x1210mm					

MIKONOS



* Custom textil printing in full color is available but not included.

SIDEWALK BOARDS Steel Boards

SIDEWALK DETAILS



INFORMATION

Kerry 2-sided structure is made of durable lacquered galvanized steel, ensuring years of durability and functionality, available in 3 colors. Designed for indoor and outdoor use. The non-glare protective cover (included) attaches easily using magnets. Ideal to advertise home sales, open houses, restaurant specials, or store sales.

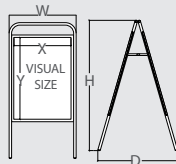

KERRY H700	QTY	N.W	G.W	C.B.M	Size (WxHxD)
Packing	1	11.8kg	12.7kg	0.0504	575x80x1095
		Visual (X-Y)	External (WxHxD)		
Product		462x662	544x1056x647		
10.691			Graphic Size: 500x700mm		

KERRY H1000	QTY	N.W	G.W	C.B.M	Size (WxHxD)
Packing	1	16.35kg	17.9kg	0.0766	760x70x1440
		Visual (X-Y)	External (WxHxD)		
Product		662x962	744x1345x814		
10.692			Graphic Size: 700x1000mm		

KERRY

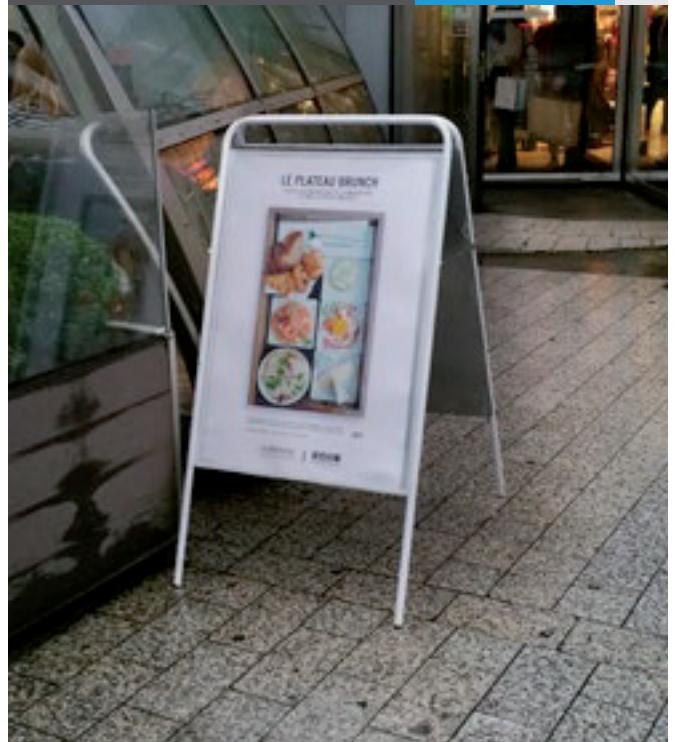

SIDEWALK DETAILS



INFORMATION

*mm

Cork 2-sided structure is made of durable lacquered galvanized steel available in 3 colors. Designed for indoor and outdoor use. Also it features a top header area. The non-glare protective cover (included) attaches easily using magnets. Ideal to advertise home sales, open houses, restaurant menu specials or store sales.

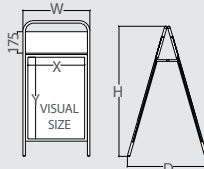

CORK H700	QTY	N.W	G.W	C.B.M	Size (WxHxD)
Packing	1	11.7kg	12.7kg	0.0459	460x70x1170
		Visual (X-Y)	External (WxHxD)		
Product		462x662	544x1056x647		
504x175					
10.695			Graphic Size: 500x700mm Top Header Gr.Size: 175x504mm		

CORK H1000	QTY	N.W	G.W	C.B.M	Size (WxHxD)
Packing	1	18.65kg	20.2kg	0.0766	760x70x1440
		Visual (X-Y)	External (WxHxD)		
Product		662x962	744x1345x814		
704x175					
10.696			Graphic Size: 700x1000mm Top Header Gr. Size: 175x704mm		

CORK



SIDEWALK DETAILS



INFORMATION

*mm

Monaghan 2-sided board is made of durable lacquered galvanized steel available in 3 colors. Designed for indoor and outdoor use. With a top header for a graphic and a non-glare protective cover. Ideal to advertise home sales, open houses, restaurant menu specials or store sales.

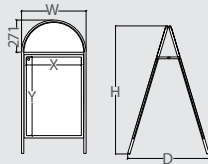

H700	QTY	N.W	G.W	C.B.M	Size (WxHxD)
Packing	1	11.7kg	12.7kg	0.0459	560x70x1170
		Visual (X-Y)	Visual Top (X-Y)		External (WxHxD)
Product		462x662	502x250		683x1078x683
10.699	<input type="radio"/>	<input type="radio"/>	<input type="radio"/>	Graphic Size: 500x700mm Top Header Gr. Size: 514x256mm	

H1000	QTY	N.W	G.W	C.B.M	Size (WxHxD)
Packing	1	7.5kg	8.9kg	0.0702	765x60x1530
		Visual (X-Y)	Visual Top (X-Y)		External (WxHxD)
Product		702x1002	702x361		742x1523x675
10.700	<input type="radio"/>	<input type="radio"/>	<input type="radio"/>	Graphic Size: 700x1000mm Top Header Gr. Size: 714x357mm	

MONAGHAN



SIDEWALK DETAILS



DIMENSIONS - LIFFORD JOINING USE

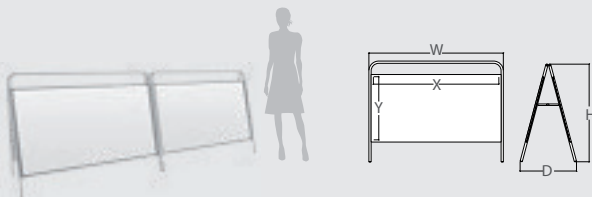

INFORMATION

Lifford 2-sided board is made of durable white lacquered galvanized steel. Designed for both indoor and outdoor. With non-glare protective cover included which attaches easily to the front using magnets. Ideal to use together with other(s) Lifford for creating a large billboard (see upper example).

LIFFORD	QTY	N.W	G.W	C.B.M	Size (WxHxD)
Packing	1	15.7kg	17kg	0.0751	935x65x1235
		Visual (X-Y)	External (WxHxD)		
Product		1120x564	1200x872x505		
10.701	<input type="radio"/>	Graphic Size: 1156x600mm			

LIFFORD



*10.701 Lifford Board at this page is sold by units, the image represented is just one example of its joint use.

SIDEWALK DETAILS



DIMENSIONS

*mm

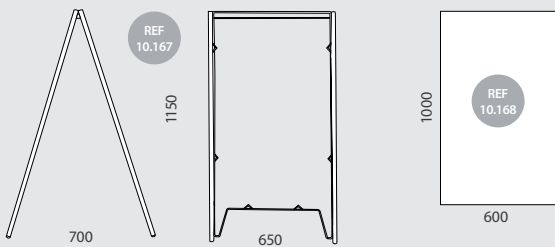

INFORMATION

The Steel A-board is made of durable Epoxi painted Steel. Featuring 6 colors available and the possibility of being used with a white board panel which is sold separately (10.168). Ideal to advertise home sales, open houses, restaurant specials, store sales or promotional services. To change out signs, just slide the poster through the steel holders.

STEEL A-BOARD	QTY	N.W	G.W	C.B.M	Size (WxHxD)
Packing	1	6kg	6.7kg	0.0523	1200x65x670
	Visual (X-Y)				External (WxHxD)
Product		600x1000			650x1150x700
10.167					
WHITEBOARD P.	QTY	N.W	G.W	C.B.M	Size (WxHxD)
Packing	1	1kg	1kg	0.0523	1200x65x670
10.168					Total Size: 600x1000mm

STEEL A-BOARD

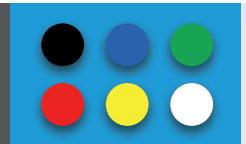

SIDEWALK BOARDS A-Board

SIDEWALK DETAILS



INFORMATION

* W: Width H: Height D: Depth * mm

The double-sided Dover A-Board features 3 different models, the first one comes with handle for an easy transportation, second one features all along customizable front for a great visual impact and the third model features a Blackboard in front of both sides.

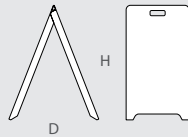

DOVER	QTY	N.W	G.W	C.B.M	Size (WxHxD)
Packing	1	1.4kg	2kg	0.0258	525x55x895
	Visual (X-Y)	13.129	Visual (X-Y)	13.130 13.131	External (WxHxD)
Product	480x715		480x815		500x820x665
13.129	Graphic Size: 480x715mm				
13.130	Graphic Size: 480x815mm				
13.131	Blackboard: 480x815mm				

DOVER



STAND DETAILS





INFORMATION

DIMENSIONS

*mm

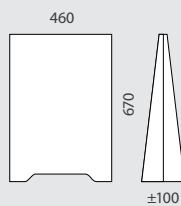
The Neiva stand A-Board has a white finish so it is ideal for customizing with your own offers or graphics. Inexpensive, durable and lightweight, making it easy to relocate as often as needed and also it's assembled in seconds. Neiva is perfect as Eye-catching advertisement for products promotion at point of sale, malls, retail stores, shopping markets.



NEIVA	QTY	N.W	G.W	C.B.M	Size (WxHxD)
Packing	2	1.74kg	2.74kg	0.0569	1055x980x55mm
13.748	460x100x670mm		x2 		

NEIVA



SIDEWALK DETAILS



DIMENSIONS

ARTWORK *mm

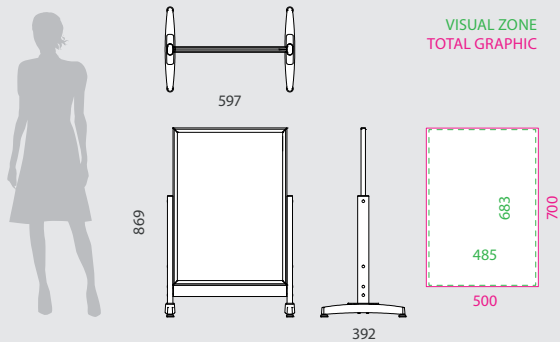

INFORMATION

Aluminium Board Display is lacquered in gray RAL 9006 and features an easy to load and upload system. With adjustable stability sturdy feet and an easy glide for the 700mm height graphic poster (9mm max.thickness) into the metal grooves of the structure and display it back-to-back. Ideal for promoting at trade shows, outside your office or showroom.

A. BOARD D.	QTY	N.W	G.W	C.B.M	SIZE
Packing	1	3.29kg	4.48kg	0.0436	880x660x75mm
13.598	Graphic Size: 500x700mm				

ALUMINIUM BOARD FRAME BASE



SIDEWALK DETAILS



DIMENSIONS

ARTWORK

*mm

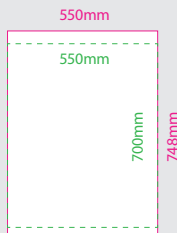
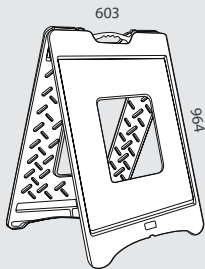

VISUAL ZONE: 550x700mm
TOTAL GRAPHIC: 550x748mm

INFORMATION

This sidewalk double sided board is built with long-lasting plastic to resist rust and other weather-related damage. Able to fit 550x748mm posters (5mm maximum thick). Fast and simple change of graphic thanks its top insert slots. Delta is lightweight and it folds down quickly for carrying and an easy storage. The non-slip feet keep them steady on both pavement and bumpy grass. It is perfect for any high-traffic area.

DELTA	QTY	N.W	G.W	C.B.M	SIZE
Packing	1	7kg	8kg	0.05	630x80x1010mm
10.679	Graphic Size: 550x748mm				

DELTA



SIDEWALK DETAILS

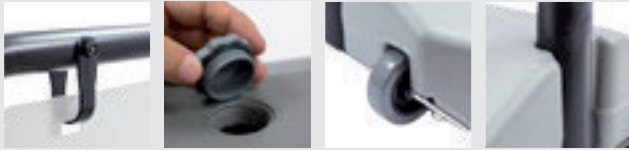
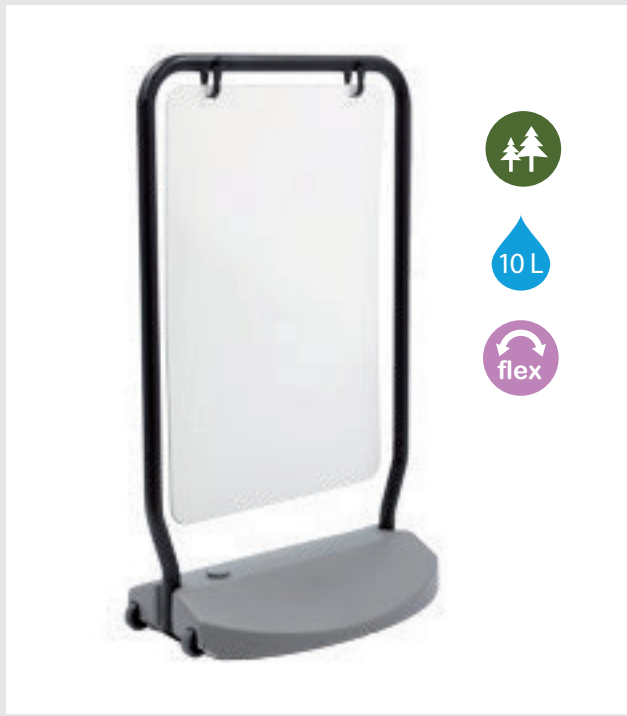

OCEAN



TRANSPORT INSTRUCTIONS



- 1 First, use the foot to tilt the board slightly toward you.
- 2 Then, move the Ocean Display behind you using its wheels.

INFORMATION

DIMENSIONS *mm

Resting on a plastic 10l water-refillable base, Ocean outdoor unit is designed for indoor and outdoor use. With an oscillating 620x1000mm board, the advertising options are numerous for your business outdoor sign. Each board is double-sided for twice the promotion. When you need to move the unit, the built-in wheels let you easily reposition to a better location or bring it inside at the end of the work day.

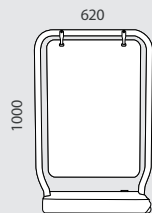

OCEAN	QTY	N.W	G.W	C.B.M	SIZE
Packing	1	5.4kg	7.0kg	0.17	1100x140x1100mm
10.305	Graphic Size: 500x750mm				



Agence Ile-de-France : 1 rue Amélia Erhart - ZAC Bel Air la Forêt - 78125 Gazeran
Siège social : 6 Chemin de Nogent - 78610 Saint-Léger-en-Yvelines
Tél. 01 30 59 29 07 | contact@info-one.fr | SIRET 488170069 00063 - APE 4651Z